

FIRE DEPARTMENT • CITY OF NEW YORK



**STUDY MATERIAL FOR THE
CERTIFICATE OF FITNESS EXAMINATION FOR
USE OF FLAMMABLE GASES WITH OXYGEN OR USE OF
LPG/CNG FOR HOT WORK OPERATIONS (CITYWIDE)
G-60**

Operation	Connecting to oxygen container?	Qualified Certificate of Fitness
LPG/CNG torch operation for torch-applied roof systems	No	G-41, G-42 or G-60
Use of LPG/CNG for asphalt melter	No	G-40, G-42
Use of oxygen and flammable gases or LPG or CNG for any hot work operation	Yes	G-60
Use of oxygen and piped natural gas for hot work operation in jewelry manufactures and dental lab facilities	Yes	G-61

TABLE OF CONTENT

NOTICE OF EXAMINATION..... *I*

STUDY MATERIAL AND TEST DESCRIPTION..... *VI*

INTRODUCTION..... *I*

Hot Work Program Authorization..... 4

DEFINITIONS..... 7

PART 1. TORCH (HOT WORK) OPERATION..... 8

1.1. Approved Location and Restricted Areas..... 9

 1.1.1. Hot Work Approved Areas 9

 1.1.2. Restricted Hot Work Areas..... 9

 1.1.3. Prohibitions for LPG and CNG10

1.2. Responsible Person and Pre-Hot Work Check..... 11

1.3. Fire Safety Requirements 13

 1.3.1. Gas Torch Operation Precautions.....13

 1.3.2. Protection of Combustibles13

 1.3.3. Signage14

1.4. Fire Watch Requirements..... 15

 1.4.1. Fire watch.....15

 1.4.2. Fire guard15

 1.4.3. Fire guard for construction sites and torch-applied roofing systems16

 1.4.4. Time and Recordkeeping requirement18

PART 2. GAS TORCH EQUIPMENT..... 19

2.1 Blowtorch (Air-fuel) and Oxy-fuel Torch..... 19

 2.1.1 Blowtorch (Air-fuel) torch or single tank torch).....19

 2.1.2 Oxy-fuel Torch.....20

2.2 Different Use of Gas Torches 21

 2.2.1 Welding and cutting.....21

 2.2.2 Brazing and Soldering22

 2.2.3 Heavy duty application.....22

2.3 Guidelines for Using an Oxygen-fuel Torch..... 24

 2.3.1 Set Up an Oxy-Fuel Torch.....24

 2.3.2 Turn On an Oxy-Fuel Torch25

 2.3.3 Turn Off an Oxy-Fuel Torch25

 2.3.4 Discontinued torch operations.26

 2.3.5 Special Precautions for Using Oxy-fuel Equipment.....26

2.4 General Guidelines for Using a Blowtorch 26

 2.4.1 Set Up a Blowtorch.....27

 2.4.2 Turn On a Blowtorch27

 2.4.3 Turn Off a Blowtorch27

2.5 Common Problems Occur With Torch Operations 27

 2.5.1 Backfire27

2.5.2	Flashback	28
2.6	Personal Protection.....	28
PART 3. COMPRESSED GAS CONTAINER.....		30
3.1	Handling, Use, and Storage of Compressed Gas.....	30
3.1.1	General Guidance	30
3.1.2	Related Equipment	32
3.1.3	Containers Connected for Use	34
3.1.4	Moving Compressed Gas Containers	34
3.1.5	Separation from hazardous conditions	35
3.1.6	Storing Containers.....	36
3.2	Handling and Use of Acetylene Gas	36
3.3	Handling and Use of LIQUID PETROLEUM GAS (LPG)	37
3.3.1	Description of Liquid Petroleum Gas	37
3.3.2	Safe Handling and Use of Liquid Petroleum Gas	38
3.4	Handling and Use of Compressed Natural Gas (CNG)	39
3.5	Check for Leaks	40
PART 4. PORTABLE FIRE EXTINGUISHERS.....		41
4.1	Operation Instructions for a Fire Extinguisher.....	42
4.2	Fire Extinguishers	43
4.3	Typical Fire Extinguishers.....	43
4.4	Fire Extinguisher Inspections.....	44

NOTICE OF EXAMINATION

Title: **Examination for Certificate of Fitness for Torch Use of Flammable Gases (G-60)**

Date of Exam: Written exams are conducted Monday through Friday (except legal holidays) 8:00 AM to 2:30 PM.

REQUIREMENTS FOR WRITTEN EXAM

Applicants who need to take the exam must apply in person and bring the following documents:

1. Applicants must be at least 18 years of age.
2. Applicants must have a reasonable understanding of the English language.
3. Applicant must provide two forms of identifications; at least one form of identification must be government issued photo identification, such as a State-issued Drivers' License or Non Driver's License or a passport.
4. Applicants must present a letter of recommendation from his/her employer. The letter must be on official letterhead, and must state the applicant's full name, experience and the address where the applicant will work. If the applicants are self-employed or the principal of the company, they must submit a notarized letter attesting to their qualifications. For more info: http://www.nyc.gov/html/fdny/html/c_of_f/cof_requirements.shtml
5. Applicants must present a completed application for certificate of fitness (A-20 Form). <http://www.nyc.gov/html/fdny/pdf/a20.pdf>
6. Applicants not currently employed may take the exam without the recommendation letter. If the applicants pass the exam, FDNY will issue a temporary letter with picture for the job seeking purpose. The C of F card will not be issued unless the applicants are employed and provide the recommendation letter from his/her employer.
7. Special requirements:
The applicants who pass **the G-60 Certificate of Fitness exam are NOT REQUIRED to obtain the G-41 Certificate of Fitness**, but are allowed to pay the additional \$25 fee to obtain the G-41 Certificate of Fitness (starting from 12/15/15).

8. APPLICATION FEE:

Pay the **\$25** application fee in person by one of the following methods:

- Cash
- Credit card (*American Express, Discover, MasterCard, or Visa*)
- Debit card (*MasterCard or Visa*)
- Personal or company check or money order (*made payable to the New York City Fire Department*)

For fee waivers submit: **(Only government employees who will use their C of F for their work-related responsibilities are eligible for fee waivers.)**

- A letter requesting fee waiver on the Agency's official letterhead stating applicant full name, exam type and address of premises;
AND
- Copy of identification card issued by the agency

A convenience fee of 2.49% will be applied to all credit card payments.

9. EXAM INFORMATION

The **G-60** exam will consist of **35** multiple-choice questions, administered on a “touch screen” computer monitor. It is a time-limit exam. It is a time-limit exam. Based on the amount of the questions, you will have **53 minutes** to complete the test. A passing score of at least 70% is required in order to secure a Certificate of Fitness. Call (718) 999-1988 for additional information and forms.

Please always check for the latest revised booklet at FDNY website before you take the exam.

http://www.nyc.gov/html/fdny/pdf/cof_study_material/g_60_st_mat.pdf

10. If all the requirements are met and pass the exam a certificate will be issued the same day. Applicant who fails the exam will receive a failure report. To retake the exam applicants will need to submit a new application and payment.

RENEWAL REQUIREMENTS

This Certificate of Fitness must be renewed every **THREE YEARS**. The renewal fee is **\$15**. FDNY also reserves the right to require the applicants to take a re-examination upon submission of renewal applications.

You will receive a courtesy notice of renewal 90 days before the expiration date. However, it is your responsibility to renew your Certificate. It is very important to renew your C of F before it expires. Renewals submitted 90 days (up to one year) after the expiration date will incur a \$25 penalty in addition to the renewal fee. Certificates expired over one year past expiration date will not be renewed. New exams will be required.

To change a mailing address:

- Submit a letter requesting the change of mailing address and a copy of your C of F with \$5.00 fee.

To change a work location,

- Submit a letter from your current employer (on company letterhead) confirming that you are an employee and stating your new work location with a copy of your C of F and a \$5.00 fee

To request a replacement certificate:

- Submit a driver’s license or passport, social security number, mailing address and a \$5.00 fee.

The certificate can be renewed **On-line, by Mail or in Person.**

- **Renewal online**

If you are an individual, make sure you have your 12 digit Certificate of Fitness Access ID. This can be found on your Renewal Notice. If you do not have your

Revised on 11/5/2015

Renewal Notice, your Access ID is your 8 digit Certificate of Fitness number and the last four digits of your social security number. If you are submitting renewals on behalf of a company's employees, the company must be approved by FDNY and have an 8 digit Company Code. To request approval, email pubrenew@fdny.nyc.gov.

Renewal fee can be paid by one of the following methods:

- Credit card (American Express, Discover, MasterCard, or Visa)
- Debit card (MasterCard or Visa)
- E-check

A fee exempted applicants cannot renew online only by mail or in person.

If all the requirements are met, the certificate of fitness will be mailed out within 10 days.

For online renewal go to: <https://a836-citypay.nyc.gov/citypay/FDNYCOF>

- **Renewal by mail**

Mail your Renewal Notice (or if you did not receive a Renewal Notice, a copy of your certificate), along with your fee payment, Personal or company check or money order (made payable to the New York City Fire Department)

For fee waivers submit: ***(Only government employees who will use their C of F for their work- related responsibilities are eligible for fee waivers.)***

- A letter requesting fee waiver on the Agency's official letterhead stating applicant full name, exam type and address of premises; **AND**

- Copy of identification card issued by the agency and if applicable, supporting documents to:

NYC Fire Department (FDNY)
Cashier's Unit
9 MetroTech Center, 1st Floor
Brooklyn, NY 11201

If all the requirements are met, the certificate of fitness will be mailed out within four to six weeks.

- **Renewal in person**

Submit your Renewal Notice (or if you did not receive a Renewal Notice, a copy of your certificate), along with your fee payment by one of the following methods:

- Cash
- Credit card (*American Express, Discover, MasterCard, or Visa*)
- Debit card (*MasterCard or Visa*)
- Personal or company check or money order (*made payable to the New York City Fire Department*)

For fee waivers submit: ***(Only government employees who will use their C of F for his or her work-related responsibilities are eligible for fee waivers.)***

- A letter requesting fee waiver on the Agency's official letterhead stating applicant full name, exam type and address of premises; **AND**
- Copy of identification card issued by the agency and if applicable, your supporting documents to:

NYC Fire Department (FDNY)
Cashier's Unit
9 MetroTech Center, 1st Floor
Brooklyn, NY 11201

If all the requirements are met, the certificate of fitness will be issued the same day.

A convenience fee of 2.49% will be applied to all credit card payments for original or renewal certificates.

Revised on 11/5/2015

EXAM SITE: **FDNY Headquarters, 9 MetroTech Center, Brooklyn, NY.** Enter through the **Flatbush Avenue entrance (between Myrtle Avenue and Tech Place).**

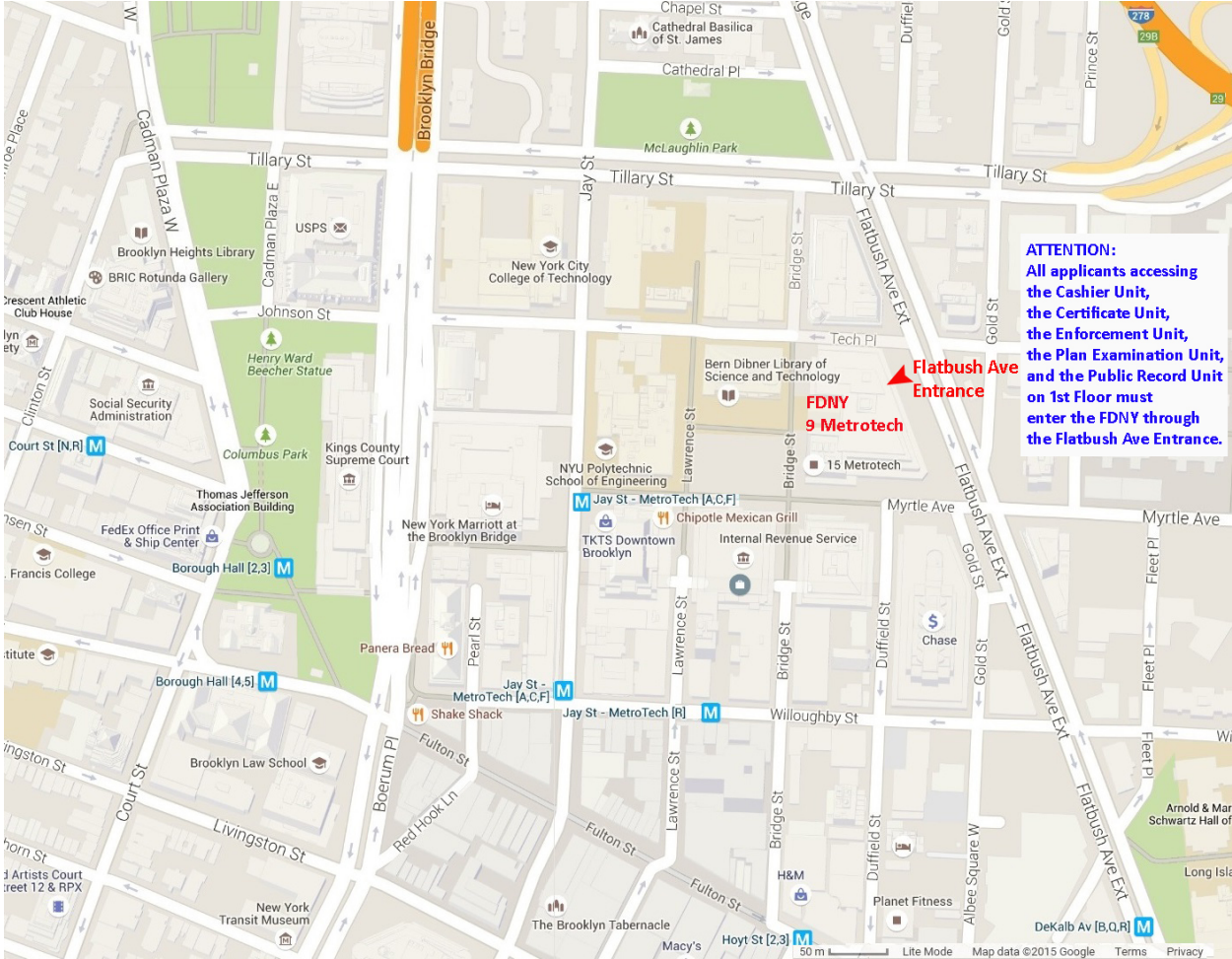

STUDY MATERIAL AND TEST DESCRIPTION

About the Study Material

This study material will help you prepare for the examination for the Certificate of Fitness for torch use of flammable gases. The study material includes information taken from the Fire Prevention Code of the Bureau of Fire Prevention. This study material consists of 4 parts. The exam covers the entire booklet and any tables. **It will not be provided to you during the test. It is critical that you read and understand this booklet to help increase your chance of passing this exam.** The study material does not contain all of the information you need to know to work with a torch. It is your responsibility to become familiar with all applicable rules and regulations of the City of New York, even if they are not covered in this study material. You need to be familiar with the National Fire Protection Association (NFPA) 51B, and Fire Code Chapter 26, Chapter 35, and Chapter 38 which regulate the torch use of flammable gases in order to adequately prepare for the exam.

About the Test

35 questions on the Certificate of Fitness examination are of the multiple choice type with four alternative answers to each question. Only one answer is most correct for each question. If you do not answer a question, or if you mark more than one alternative your answer will be scored as incorrect. A score of 70% is required on the examination in order to qualify for the Certificate of Fitness. Read each question carefully before marking your answer. There is no penalty for guessing.

Sample Questions

1. Who was the first President of the United States?

- (A) George Jefferson.
- (B) George Washington
- (C) Bill Clinton.
- (D) Barack H. Obama.

The correct answer is "**B**". You would press "**B**" on your computer terminal.

2. The city in the United States referred to as The Big Apple is:

- (A) Los Angeles.
- (B) Buffalo.
- (C) Florida.
- (D) New York.

The correct answer is "**D**". You would press "**D**" on your computer terminal.

INTRODUCTION

This document outlines New York City Fire Department regulations for welding, cutting and other torch and hot work operations and equipment. Hot work processes are a necessary part of much construction work and industrial work. However, the improper use is often a major cause of fire and it can result in loss of life and property.

Certificate of Fitness

According to the Fire Code, a Certificate of Fitness is needed for connecting and disconnecting of LPG containers with a capacity equal to or greater than 16.4 oz or CNG containers with a capacity greater than 8.7 SCF. When such connecting and disconnecting is performed by a LPG/CNG supplier or distributor, a card or tag must be conspicuously posted at the premises identifying the name and address of the supplier or distributor, the name of the Certificate of Fitness holder, and the number and expiration date of the Certificate of Fitness.

In addition, the following torch operation must be conducted by a qualified Certificate of Fitness:

Operation	Connecting to oxygen container?	Qualified Certificate of Fitness
LPG/CNG Torch operation for torch-applied roof systems	No	G-41, G-42 or G-60
Use of LPG/CNG for asphalt melter	No	G-40, G-42
Use of oxygen and flammable gases or LPG or CNG for any hot work operation	Yes	G-60

Exception:

Torch operations using oxygen container and **piped natural gas** for jewelry manufacture may be performed by a person without a C of F, but must be under the personal supervision of a G-61 Certificate of Fitness holder, who must regulate the pressure and flow of oxygen and natural gas to each torch.

The Certificate of Fitness holder must keep the Certificates of Fitness upon his or her person or otherwise readily available for inspection by any representative of the Department, at all times while conducting or supervising the material, operation or facility for which the certificate is required.

FDNY Permit

Permits issued by the FDNY are required to conduct the following hot work:

- (1) storing, using or handling oxygen and a flammable gas,
or
- (2) storing, using or handling any flammable gas (e.g. LPG or CNG or acetylene) in excess of 400 SCF.
or
- (3) storing, using or handling any oxidizing gas (e.g. oxygen) in excess of 504 SCF.



For LPG, 400 SCF is approximately 47 lbs. The following table lists the number of LPG containers for the storage, use, handling or transportation, requiring a permit. This permit will be issued by the Fire Commissioner after the location has been inspected and approved as acceptable for such practices.

LPG Container Capacity	Number of Containers Requiring Permit
14.1 oz	54
16.4 oz	46
20 lbs	3
33.5 lbs	2
40 lbs	2
100 lbs	1

Portable **LPG** containers that are more than **16.4 oz** and **CNG** containers with a capacity greater than **8.7 SCF** must NOT stored, handled, or used indoors in the following occupancies (as defined in the Building code): residential occupancies, factory and industrial occupancies; educational occupancies; institutional occupancies, except as the commissioner may authorize by rule.

Any single standard portable LPG container must not exceed 100 lbs in weight. Any single CNG container must not exceed 381 SCF.

A LPG/CNG permit will not be issued by the FDNY for a stationary LPG/CNG installation located in an area where access to piped natural gas from a public utility is available.

Example of LPG container with a capacity of 20 lbs	Example of LPG container with a capacity of 100 lbs
	

Types of FDNY Permits

(1) Site-specific permit

Such permit authorizes the permit holder to store, handle, or use flammable gases, or conduct a torch operation at a specific premises or location. A site-specific permit may be a permanent permit or a temporary permit. Permanent permits are valid for 12 months only. Every permits or renewal shall require an inspection and shall expire after twelve months. Temporary permit may be valid from one day to 12 months depends on the construction /operation need. For example, a one-week temporary permit may be issued to a construction job which only takes one week. Normally, a hot work operation (e.g. construction site or hot work repair) is issued a temporary permit.

Example of a permanent FDNY permit

FIRE DEPARTMENT, CITY OF NEW YORK					BUREAU OF FIRE PREVENTION								
ACCOUNT NUMBER	TYPE	A.P.	D.O.	ADM. CO.	ISSUANCE DATE	PERMIT EXPIRES							
7777777	10	P	12	E284	01/28/10	01/11							
PREMISES ADDRESS				ACCOUNT NAME									
1111 YORK ST STATEN ISLAND NY 11111				CARI & RENO									
ITEM CODE	SUB CODE	QTY	DESCRIPTION	FLOOR NO.	FEE								
345	00	1	COMPRESSED GASES ONLY STR/USE	1	PAID								
<table border="1"> <tr> <td>PERMIT TYPE</td> <td>ANNUAL FEE</td> <td>FEE</td> </tr> <tr> <td>1</td> <td></td> <td>PAID</td> </tr> </table>								PERMIT TYPE	ANNUAL FEE	FEE	1		PAID
PERMIT TYPE	ANNUAL FEE	FEE											
1		PAID											
1=REGULAR 2=SUPPLEMENTAL 3=DUPLICATE		CARI & RENO 1111 YORK ST STATEN ISLAND NY 11111											
 20 11012938				BY ORDER OF THE COMMISSIONER									

Example of a temporary FDNY permit

D.O.	COMPANY	BORO	ACCOUNT NO.	TOTAL FEE	PERMIT EXPIRES
01		MANH	3333333	\$ 525.00	02 24 11
Expiration Date: 11 01 11			PERMIT COVERS:		
THE CITY OF NEW YORK FIRE DEPARTMENT Bureau of Fire Prevention 9 Metro Tech Center Brooklyn, N.Y. 11201-3857					
F 02872 Postal Address of Permit Holder or Agent: KARLIN PIPING INDUST. 347 REM WAY WADING RIVER, N.Y., 11792			CODE NO: 345 OXYGEN STORAGE LT & CONSTRUCTION SITE 346 ACETYLENE STORAGE LT & CONSTRUCTION SITE 347 USE OXYGEN AND ACETYLENE TORCH LT & CONSTRUCTION SITE NOTE: OXYGEN AND ACETYLENE CYLINDERS SEPARATELY STORED IN APPROVED CAGES AT GROUND LEVEL		
Occupancy for which this Permit is issued and at which it must be displayed: 13110 WEST 11 STREET NEW YORK, N.Y., 10011					
New York <u>MANHATTAN</u> Pursuant to the provisions of the administration Code and the regulations made thereunder, the above permittee is hereby authorized by the Fire Commissioner to store and use HAZARDOUS MATERIALS in the quantity specified. This permit is revocable at the pleasure of the Commissioner, and is issued with the express understanding that the articles herein named are to be stored and kept in accordance with the provisions of the law; that the permittee will use all possible care to avoid accidents; that it is only available for the location and permittee named.					
 Fire Commissioner					

This temporary permit is valid for 7 months.

(2) Citywide permit

Such permit authorizes the permit holder to store, handle, use or sell hazardous materials, or conduct an operation on a citywide basis. A citywide permit is valid to temporarily store, handle, use or sell hazardous materials or to conduct an operation at one or more locations subject to the following restrictions:

- The duration of such activity at any individual location does not exceed **30 calendar days** and **all hazardous materials associated with such activity are removed from the location at the end of the workday**. Periods of activity in excess of 30 calendar days at any one location shall require a site-specific permit.
- The quantity of hazardous materials being temporarily stored and used does not exceed 5 gallons of gasoline, or 250 gallons of any other flammable liquid, and 300 gallons of any combustible liquid. Storage or use of hazardous materials in quantities exceeding these amounts requires a site-specific permit for each location at which such storage or use occurs.

(3) Transportation permit

Such permit authorizes the permit holder to transport, pick up and deliver hazardous materials. Any person who transports any hazardous material in the quantity of requiring a FDNY permit has to apply for a FDNY transportation permit. The FDNY transportation permit (sticker) must be displayed on the vehicle.

Example of a FDNY transportation permit (a sticker)

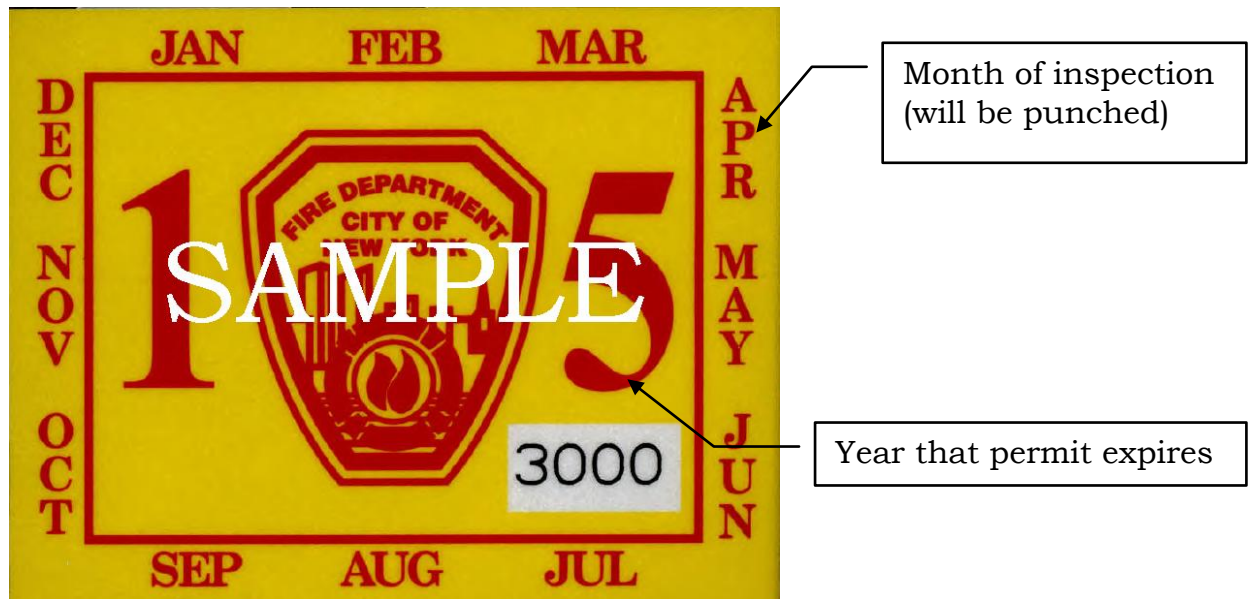

All permits are not transferable, and any change in occupancy, operation, tenancy or ownership requires that a new permit be issued. The Certificate of Fitness holder is responsible for making sure that all fire safety regulations and procedures are obeyed on the premises. **Permits shall be readily available on the premise for inspection by Fire Department representatives.**

Hot Work Program Authorization

A hot work program authorization is required for any project conducted on premises involving hot work operations. Hot work program authorization is NOT issued by the FDNY,

Revised on 11/5/2015

it must be signed and issued by the **responsible person**, and it must be available for inspection by any representative of the Fire Department during the performance of the work, and for **48 hours after the work is complete**.

An authorization for hot work operations shall not be issued unless the individuals conducting such operations are capable of performing such operations safely.

The operation of gas torches is required to comply with the following FDNY code and rule sections:

- Welding and Other Hot Work: **[FC Chapter 26]**
- Flammable Gases: : **[FC Chapter 35]**
- Liquefied petroleum gases: **[FC Chapter 38]**
- Fire Prevention During Welding, Cutting and Other Hot Work: **[NFPA 51B, 2003 edition]**
- Portable Space Heaters Fueled By Piped Natural Gas at Construction Sites **[Rule 1403-01]**
- Use of Oxygen and a Flammable Gas in Citywide Hot Work Operations **[Rule 2605-01]**
- Piped Natural Gas and Oxygen Consuming Devices and Installations **[Rule 2609-01]**
- Acetylene **[Rule 3501-01]**
- Compressed Natural Gas **[Rule 3507-01]**
- Liquefied Petroleum Gases **[Rule 3809-01]**

HOT WORK PROGRAM AUTHORIZATION

This authorization is required for any project conducted on premises involving hot work operations. Hot work operation includes cutting, welding, thermit welding, brazing, soldering, grinding, thermal spraying, thawing pipe, cadwelding, installation of torch-applied roof systems or any other similar operation or activity.

An authorization for hot work operations shall not be issued unless the individuals conducting such operations are capable of performing such operations safely.

This authorization shall be available for inspection by any FDNY representative during the performance of the work and for 48 hours after the work is complete.

Date: _____	Hot work by <input type="checkbox"/> employee <input type="checkbox"/> contractor
Location: Building address, room # and/or area of work: _____ _____	Work to be done _____ _____
Time started _____ Time completed _____	I verify that the above location has been examined, the pre-hot work checks marked on the checklist below have been taken and permission is granted for this work.
THIS AUTHORIZATION GOOD FOR ONE DAY ONLY	Name (print) and signature of the responsible person: _____

The hot work equipment is in good working order.

The hot work area is clear of combustibles and flammable solids:

(35 Feet rule for cutting or welding operation; 25 feet rule for other hot work operation)

- Any container or equipment that contains or has contained a flammable solid, flammable liquid or flammable gas is removed.
- Explosive atmosphere in area eliminated
- Any combustible material and combustible waste is removed or be provided with appropriate shielding.

Exposed construction is of noncombustible materials or, if combustible, is protected.

Openings are protected.

Hot work area floors are clear of combustible waste accumulation.

Fire watch personnel, where required, are assigned.

Fire guard (Name and signature) : _____ Cof # _____ Exp Date: _____

Approved actions have been taken to prevent accidental activation of fire extinguishing systems and detection equipment.

- Available sprinklers are in service and operable. Sprinkler system protection must not be shut off or impaired.
- Approved precautionary measures shall be taken to avoid accidental operation of automatic fire detection systems.
- Portable fire extinguishers and fire hoses (where provided) are operable and available.

All persons performing hot work possess certificates of fitness, where such certificates are required

Torch operator (Name and signature) _____ Cof # _____ Exp Date: _____

All persons performing hot work requiring a permit possess a FDNY permit, authorizing such work.

Final Check

Work area and all adjacent areas to which sparks and heat might have spread were inspected 30 minutes after the work was completed and were found fire safe.

Fire guard (Name and signature) : _____ Cof # _____ Exp Date: _____

Second inspection for torch operation using LPG/CNG: work area and all adjacent areas were inspected 1 hour after the work was completed and were found fire safe.

Fire guard (Name and signature) : _____ Cof # _____ Exp Date: _____

DEFINITIONS

CNG: Compressed Natural Gas.

FIRE GUARD: A person holding a Certificate of Fitness for such purposes, who is trained in and responsible for maintaining a fire watch and performing such fire safety duties as may be prescribed by the commissioner.

FIRE WATCH: A temporary measure intended to ensure continuous and systematic surveillance of a building or portion thereof by one or more qualified individuals for the purposes of identifying and controlling fire hazards, detecting early signs of fire, raising an alarm of fire, and notifying the department.

HOT WORK: Cutting, welding, thermit welding, brazing, soldering, grinding, thermal spraying, thawing pipe, cadwelding, installation of torch-applied system, or any other similar operation or activity.

HOT WORK AREA: The area exposed to sparks, hot slag, radiant heat, or convective heat as a result of hot work.

HOT WORK EQUIPMENT. Electric or gas welding or cutting equipment used for hot work.

HOT WORK PROGRAM. A program, implemented by a responsible person designated by the owner of a building or structure in or on which hot work is being performed, to oversee and issue authorizations for such hot work for the purpose of preventing fire and fire spread.

HOT WORK PROGRAM AUTHORIZATIONS. Authorizations issued by the responsible person under a hot work program allowing welding or other hot work to be performed at the premises.

LPG: Liquefied Petroleum Gases.

NFPA: National Fire Protection Association. NFPA develops, publishes, and disseminates more than 300 consensus codes and standards intended to minimize the possibility and effects of fire and other risks.

PERSONAL SUPERVISION. Supervision by the holder of any department certificate who is required to be personally present on the premises, or other proximate location acceptable to the department, while performing the duties for which the certificate is required.

RESPONSIBLE PERSON: A person trained in the fire safety hazards associated with hot work, and in the necessary and appropriate measures to minimize those hazards, who is designated by the owner of a premises to authorize the performance of hot work at the premises.



SCF: Standard Cubic Feet.



TORCH-APPLIED ROOF SYSTEM: Bituminous roofing systems using membranes that are adhered by heating with a torch and melting asphalt back coating instead of mopping hot asphalt for adhesion.

PART 1. TORCH (HOT WORK) OPERATION

Normally, the gas mixture is manually ignited by the operator when it leaves the torch. The flame itself can reach extremely high temperatures. A high temperature flame is needed to heat the metal. However, usually it is not the flame that causes a fire. Instead, **it is the thousands of sparks and slag that are generated when using the torch.** The sparks and slag are the sources of ignition in about 60% of all fires in industrial occupancies. This number is greatly reduced when the operators are trained to use the equipment correctly.

Fire History Summary

Date	Fire Summary	Lessons Learned	
Nov. 2010	<p><u>Chinese city of Shanghai construction fire</u> Sparks from welding equipment set a light nylon construction netting and bamboo scaffolding that nearly covered the building. 58 people died and 56 still missing, and more than 120 are injured.</p>	<p>There should be a safe distance between the combustible materials (in this case the bamboo scaffolding) the hot work operations area, or there should be a fire guard watching for sparks.</p>	
July 2009	<p><u>Throgs Neck construction fire, Queens, NY</u> At 5 a.m. a fire started near scaffolding and flammable construction materials on the Queens-side bridge approach by a construction worker's blow torch.</p>	<p>Although still under investigation, the cause reflects a lack of fire safety at the construction site.</p>	
June 2009	<p><u>5-story apartment construction fire, Renton, WA</u> Several spot fires from a roof torch had fallen into the void between the insulation, ceiling, and roof assembly, and a breeze provided enough air for a fire to flare up early hours later. The fire spread rapidly through the wooden construction. \$12 million damage estimate in this fire.</p>	<p>Sheetrock had not yet been installed to protect the wood framing. There should be a fire guard watching for sparks.</p>	

Date	Fire Summary	Lessons Learned	
Mar. 2009	<p><u>Casino Fire, Joliet, IL</u> A fire sparked by a construction worker welded a kitchen hood in an area of the casino. The fire caused heavy damage to sections of the Empress Casino and firefighters had to truck in water to contain the blaze. \$340 million damage estimate in this fire.</p>	<p>There should be a fire guard watching for sparks.</p>	
Dec. 2000	<p><u>Dongdu Commercial Building construction, Luoyang, China</u> Construction workers in the basement dropped molten metal on flannel rags and wooden furniture. The welders fled without warning, and workers on 2nd and 3rd floor, as well as 200 guests at an illegal party, were trapped. 309 people died.</p>	<p>Only 60 escaped the fire, as construction material and merchandise blocked exits. Firefighters used cranes to attempt rescues, and the fire took 3 hours to extinguish. The welders who started the fire were performing unlicensed renovation work.</p>	

Sources

Arnold, Jim. "Large Building Fires and Subsequent Code Changes". April 7, 2005.
 FDNY: Worker's blow torch started Throgs Neck fire. (2009, July 13). *Newsday*.
 Small Fire causes damage at hospital construction site. (2010, February 16). *Daily Sound*.
 Stephen G. Badger. "US Large-Loss Fires in 2009". (2010, November/ December). *NFPA Journal*.

Fire watch is to oversee torch operations. This fire watch person ensures that sparks and slags do not cause a fire in the area of hot work or the floor below if required. A portable extinguisher must be within immediate reach to extinguish any potential fire situation.

1.1. Approved Location and Restricted Areas

1.1.1. Hot Work Approved Areas

Hot work may be conducted in the following areas:

1. Areas designed for hot work operations (e.g. jewelry factory).
2. Areas authorized for that purpose by the responsible person at the premises when precautions have been taken in compliance with the requirements of Fire Code (e.g. areas with hot work authorization).

1.1.2. Restricted Hot Work Areas

Hot work must not be conducted in the following areas:

1. Areas where the sprinkler system is impaired.
2. Areas where there exists the potential of an explosive atmosphere, such as locations where flammable gases, liquids or vapors are present.
3. Areas with readily ignitable materials, such as storage of large quantities of bulk sulfur, baled paper, cotton, lint, dust or loose combustible materials.
4. On board marine vessels or watercraft at dock under construction or repair.

1.1.3. Prohibitions for LPG and CNG

Description	LPG	Exception	CNG	Exception
Store, handle or use it in a basement, cellar or other below grade area	Prohibited	Emergency indoor Repairs (except in an occupied place of public assembly), manhole operation	Prohibited	Emergency indoor Repairs (except in an occupied place of public assembly), manhole operation
Store, handle or use it in, or bring it or allow it into, any residential occupancy, or on any lot containing a building used for a residential occupancy, or any non-residential building	Prohibited for any LPG container with a capacity greater than 16.4 ounces	Emergency indoor Repairs (except in an occupied place of public assembly)	Prohibited for any CNG container with a capacity greater than 8.7 SCF	Emergency indoor Repairs (except in an occupied place of public assembly)
Store the containers on the roof of any building	Prohibited		Prohibited	
Handle or use it on the roof of any building	Prohibited for any LPG containers with a capacity greater than 16.4 ounces.	Emergency indoor Repairs (except in an occupied place of public assembly)/Asphalt melter	Prohibited for any CNG containers with a capacity greater than 8.7 SCF	Emergency indoor Repairs (except in an occupied place of public assembly)/ Asphalt melter.
Store, handle or use it in or on motor vehicles	Prohibited	Temporary storage incidental to transportation, or as a fuel for generating motive power for a motor vehicle	Prohibited	Temporary storage incidental to transportation, or as a fuel for generating motive power for a motor vehicle
Store, handle or use it for a stationary installation in any area where access to pipel natural gas from a public utility is available, except as authorized by the commissioner.	Prohibited		Prohibited	
Store, handle or use it for space heating or water heating	Prohibited	Residentially occupied moored vessels	Prohibited	Residentially occupied moored vessels
Use non-metallic pipe , tubing and components	Prohibited	Construction sites, emergency indoor repairs, manhole operations	Prohibited	Construction sites, emergency indoor repairs, manhole operations
Dispense LPG/CNG, fill a container with LPG/CNG, or transfer LPG/CNG from one container to another	Prohibited		Prohibited	Fill the permanently mounted CNG containers on CNG-powered vehicles

1.2. Responsible Person and Pre-Hot Work Check

For hot work operation with citywide permit, the owner of the premises of the hot work operation areas must be notified in writing by the citywide permit holder **at least 48 hours before** the hot work is to be started.

For all hot work operations, the owner of the hot work operation areas must designate a responsible person. The responsible person must ensure that the hot work is performed in compliance with the terms and conditions of the permit. The person should inspect the hot work site prior to issuing the hot work program authorization to ensure that it is a fire safe area. He/she also need to periodically monitor the work as it is being performed to ensure there are no fire safety hazards. Hot work operations must be conducted under the general supervision of the responsible person.

Before hot work is authorized and at least once per day while the authorization is in effect, the hot work area shall be inspected by the responsible person to ensure that it is a fire safe area.

The pre-hot work check must be conducted by the responsible person before hot work is authorized and at least once per day. The check reports must be kept at the work site during the work, made available for inspection by a representative of the FDNY, and **maintained on the premises for a minimum of 48 hours after work is complete.**

A pre-hot work check must be conducted at least once per day and must verify the following:

1. The hot work equipment is in good working order.
2. The hot work area is clear of combustibles and flammable solids.

(1) 35 feet rule for cutting or welding operation

Hot work operations involving cutting or welding shall be conducted at least 35 feet from combustible materials and combustible waste or shall be provided with appropriate shielding to prevent sparks, slag or heat from igniting exposed combustibles.

(2) 25 feet rule for other hot work operation

All other hot work operations shall be conducted at least 25 feet from combustible materials and combustible waste or shall be provided with appropriate shielding to prevent sparks, slag or heat from igniting exposed combustibles.

The 2009 edition of National Fire Protection Association 51B shows the 35-ft. rule in a 3-D perspective. Detail information refer to Chapter 5 of NFPA 51B, 2009.

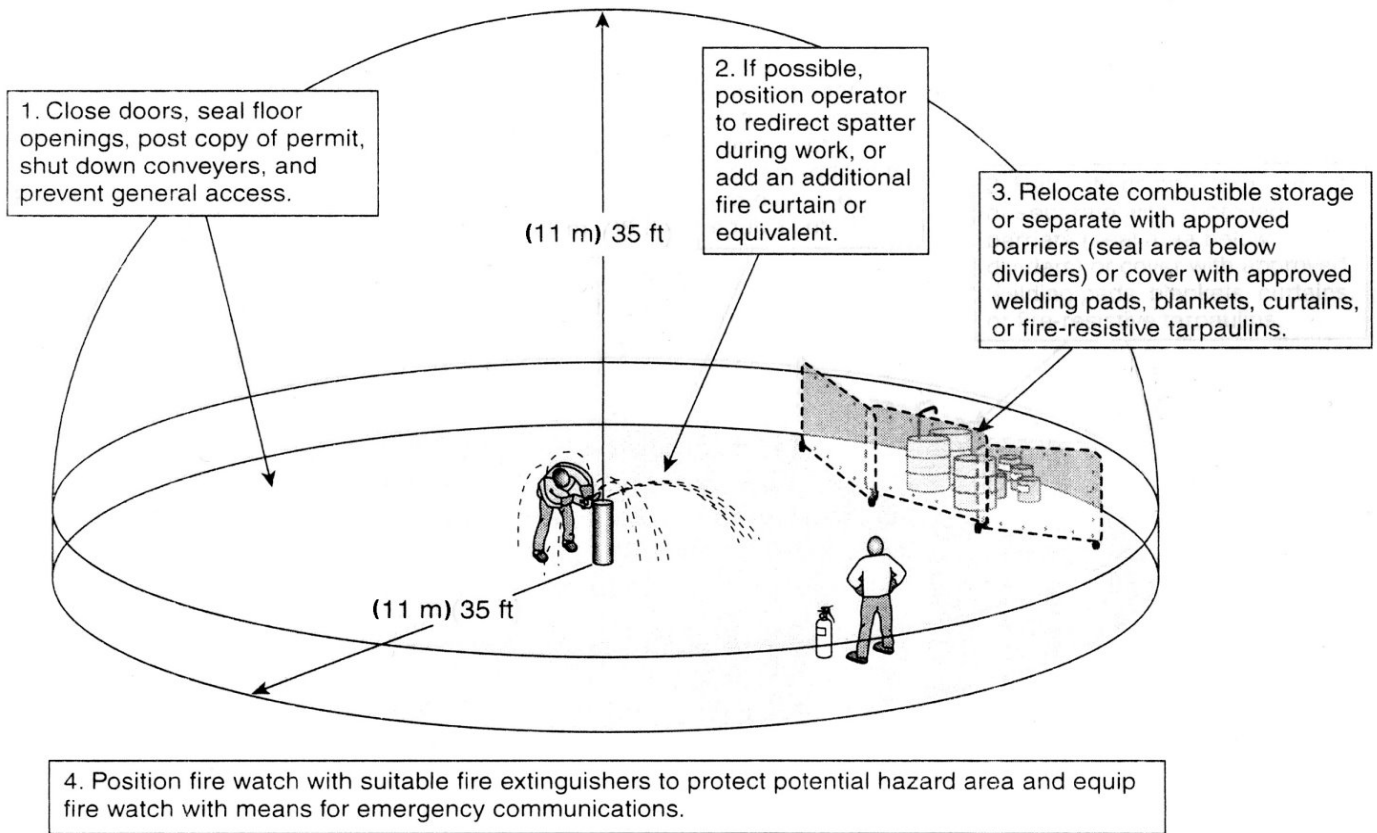

3. Exposed construction is of noncombustible materials or, if combustible, is protected.
4. Openings are protected.
5. Hot work area floors are clear of combustible waste accumulation.
6. Fire watch personnel, where required, are assigned.
7. Approved actions have been taken to prevent accidental activation of fire extinguishing systems and detection equipment.

(1) Sprinkler protection.

Sprinkler system protection **must not be shut off or impaired** while hot work is performed. Where hot work is performed close to sprinklers, noncombustible barriers or damp cloth guards shall shield the individual sprinkler heads and shall be removed when the work is completed. If the work extends over several days, the shields shall be removed at the end of each workday.

(2) Fire detection systems.

Approved precautionary measures shall be taken to avoid accidental operation of automatic fire detection systems. For example, the fire alarm system (e.g. smoke detectors) may need to be taken out of service during the hot work operation to avoid unwarranted alarms. The date and time the alarm system was taken off-line, the reason for such action, the name and operator number of the person notified at the central station (or other evidence of notification satisfactory to the Department), and the date and time the system was restored to service, must be entered in the alarm log book in each such circumstance. Fire watch for impairment must be provided when the alarm system is off-line.

9. Portable fire extinguishers and fire hoses (where provided) are operable and available.

10. All persons performing hot work possess certificates of fitness, where such certificates are required.
 - (1) G-60 certificates of fitness is required for torch operations using oxygen and a flammable gas
 - (2) G-60 or G-62 certificates of fitness is required for torch applied roof system.
 - (3) F-60 certificates of fitness fire guard is required to perform the fire watch for torch operations at (a) construction sites, (b) on any rooftop, or (c) in any building or structure, when the torch operation is conducted by a person holding a citywide permit for torch operations
11. All persons performing hot work requiring a permit possess a site-specific permit or citywide permit, authorizing such work.

1.3. Fire Safety Requirements

1.3.1. Gas Torch Operation Precautions

Each person must operate only one torch at a time and such torch must not be left unattended while ignited.

The torch equipment should only be used for purposes for which it was intended. It should not be used for any kind of tricks or stunts. This could result in serious or fatal injuries.

1.3.2. Protection of Combustibles

Areas designed for hot work operations shall have floors with noncombustible surfaces. Paper, wood shavings, straw and fabric are examples of combustible materials. Hot work operations involving cutting or welding shall be conducted at least 35 feet from combustible materials and combustible waste or shall be provided with appropriate shielding to prevent sparks, slag or heat from igniting exposed combustibles.

All other hot work operations shall be conducted at least 25 feet from combustible materials and combustible waste or shall be provided with appropriate shielding to prevent sparks, slag or heat from igniting exposed combustibles.

Combustible waste shall not be allowed to accumulate on floors and other surfaces within the hot work area. Hot work areas shall be regularly cleaned and combustible waste removed and disposed of lawfully.

If possible, the combustible materials should be moved to a safe location. If relocation of the combustible materials is impractical, combustibles, openings or cracks in walls, floors, ducts or shafts within 35 feet of the hot work area must be tightly covered to prevent the passage of sparks to adjacent combustible areas, or shielded by metal or fire-retardant guards, or provided with curtains to prevent passage of sparks or slag. They may also be wetted down as an added precaution. Ducts and conveyor systems that might carry sparks to distant combustibles must be shielded, or shut down, or both. If hot work is done near walls, partitions, ceilings, or roofs, ignition of combustibles on the other side must be prevented.

It is prohibited to perform welding or cutting when supported by or resting on any compressed gas containers. Hot work shall not be performed on a container or equipment that contains or has contained a flammable solid, flammable liquid or flammable gas until the container or equipment has been thoroughly cleaned and purged. Hot work involving

Revised on 11/5/2015

cutting, welding or heating of any flammable solid in any form shall be conducted only with an approval of the FDNY.

Partitions segregating hot work areas from other areas of the building shall be of noncombustible construction. In fixed hot work areas, the partitions shall be securely connected to the floor such that no gap exists between the floor and the partition. Partitions shall prevent the passage of sparks, slag, and heat from the hot work area.



Special requirement for a repair garage:

The use of a torch within a repair garage located on a property upon which a motor-fuel dispensing facility is situated must be conducted within a fire-rated enclosure (approved by the Building Department). All doors of such enclosure shall be fireproof and self-closing.

In a repair garage with a capacity for more than one vehicle, hot work shall be conducted within a fire-rated enclosure or behind a noncombustible screen that is positioned and of sufficient size to prevent the passage of sparks, slag and heat from the hot work area.

1.3.3. Signage

Where the hot work area is accessible to persons other than the operator of the hot work equipment, visible hazard identification signs must be posted in a conspicuous location to warn others before they enter the hot work area. An example warning sign is shown below.



A copy of the FDNY permit and hot work authorization are to be kept by the fire guard or the person who performs the fire watch. Copies of completed permits will be maintained in the project files. All hot work authorizations must be returned to the responsible person upon completion of work for the day to confirm that work in the area has been concluded. This returned authorization must be filed with the FDNY hot work permit section with the appropriate original.

1.4. Fire Watch Requirements

1.4.1. Fire watch

A fire watch must be maintained during any hot work operation. The fire watch shall observe the entire hot work area. Hot work conducted in areas with vertical or horizontal fire exposures that are not observable by a single individual shall have additional personnel assigned to ensure that exposed areas are monitored.

Persons conducting a fire watch shall keep constant watch for fires with respect to the areas being monitored in connection with hot work operations. **The persons conducting a fire watch shall not have other duties.**

Where hose lines are required, they shall be connected, charged and ready for operation. At least one portable fire extinguisher with a minimum **2-A:20-B:C** rating shall be provided and readily accessible within a **30 feet** travel distance of the location where hot work is performed and where the fire guards are positioned.

Exception: **There shall be not less than one multi-purpose portable fire extinguisher with a minimum 3-A 40-B:C rating for roofing operations utilizing heat-producing systems or other ignition sources.**

A fire watch personnel should be present with a minimum 2-A:20-B:C rating fire extinguisher to perform fire watch during the hot work operations.



1.4.2. Fire guard

The fire watch for torch operations conducted at the following three locations shall be conducted by at least one F-60 fire guard:

- (1) **Construction sites.**
- (2) **In any building or structure, when the torch operation is conducted by a person holding a citywide permit for torch operations.**
- (3) **On any rooftop, or in connection with any torch-applied roofing system operation.**

It is important to understand the code-required distinction between a fire watch and a fire guard. Not all individuals responsible to maintain a fire watch must possess an F-60 certificate of fitness.

1.4.3. Fire guard for construction sites and torch-applied roofing systems

It shall be unlawful to install any roofing material using a torch on a roof of combustible construction, or otherwise engage in roofing operations on roofs of combustible construction using hot work equipment.

A torch-applied roof system is a bituminous roofing system using membranes that are adhered by heating with a torch and melting asphalt back coating instead of mopping hot asphalt for adhesion. It is widely used in US, torch-applied operations can be hazardous to roofers and the public. Improper torch use or careless fire watch has caused many rooftop fires. Fire guards must be on continuous duty during all torch operations on the roof of a building.

At a construction site and torch-applied roofing system operation, every torch operator must also have a person performing fire watch by a F-60 fire guard.

Exception:

The single fire guard may be designated to conduct a fire watch for more than one torch operation on the same floor or level if each torch operation is not more than 50 feet from the fire guard, as measured by the actual path of travel, and the field of view of such fire guard encompasses all of the horizontal fire exposures of such torch operations.

Fire watch on floors below: Additional F-60 fire guard is required to perform fire watch on floor below if the torch operation is being conducted at or near the edge of an unenclosed floor of a building, or near a floor opening, or other location where sparks and slag may travel to one or more lower floors or levels.



Fire watch is required for adjoining areas and below to make sure that sparks do not cause a fire on the adjoining areas.

This additional fire guard must conduct a fire watch on each lower floor or level containing combustible surfaces or materials within 35 feet of the area of such floor or level that

potentially would be exposed to such sparks or slag. Prior to commencement of the torch operation, the fire safety manager or responsible person shall inspect the lower floors or levels and take all necessary and appropriate precautions to protect any combustible surfaces and materials that potentially would be exposed to sparks and slag from the torch operation. A certification to that effect must be made on the hot work authorization.

Exception:

1. A fire watch is not required on the floors/levels below a torch operation on a construction site when ALL the following conditions are met:
 - 1.1. the torch operation is not being conducted at or near the edge of an unenclosed floor of a building;
 - 1.2. the floor upon which the torch operation is being conducted is of noncombustible construction;
 - 1.3. there are no floor or exterior building openings within 35 feet of the torch operation; AND
 - 1.4. prior to commencement of the torch operation, the fire safety manager or responsible person conducts an inspection and takes the precautions to protect any combustible surfaces and materials that potentially would be exposed to sparks and slag from the torch operation.
2. Notwithstanding the foregoing exception, if sparks or slag generated by the torch operation are observed to extend beyond 35 feet, thereby potentially exposing lower floors or levels, the torch operation shall be immediately discontinued, and the floors or levels below shall be inspected for any fire condition. If there is any potential exposure surfaces or materials on the floors below from such sparks and slag, noncombustible barriers shall be provided and any other necessary or appropriate precautions shall be taken. If such barriers and precautions fail to block the passage of sparks and slag, a fire watch shall be established on the floors or levels below.

The 2009 edition of National Fire Protection Association 51B shows the 35-ft. rule in a 3-D perspective to account for multiple fire watchers. Detail information refer to Chapter 5 of NFPA 51B, 2009 .

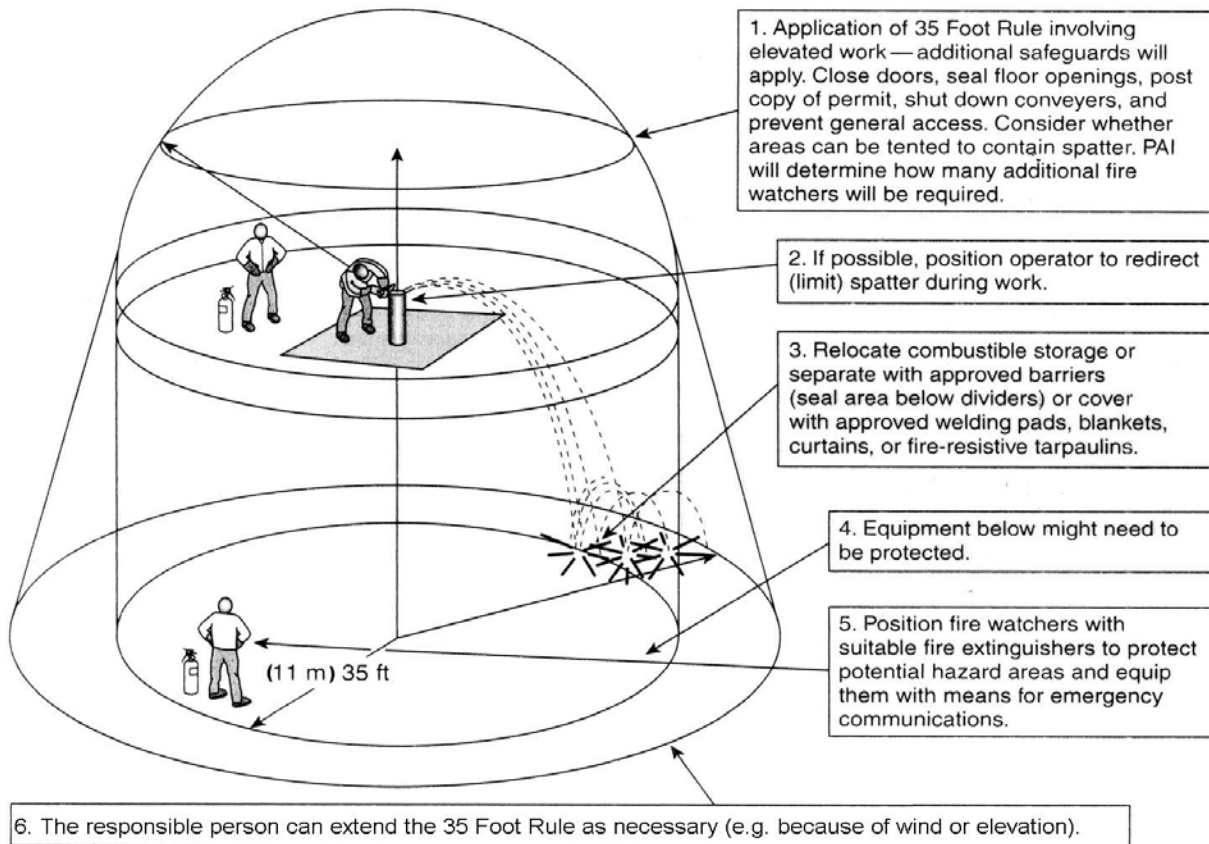

1.4.4. Time and Recordkeeping requirement

A fire watch must be maintained during any hot work operation. The fire watch must continue for a minimum of 30 minutes after the conclusion of the work. The commissioner, or the responsible person implementing a hot work program, may extend the duration of the fire watch based on the hazards or work being performed.

For any CNG or LPG torch operation, **the first inspection shall be conducted 30 minutes after completion of torch operations; the second inspection 1 hour after completion of torch operations.** This is to make sure that there are no smoldering fires in the building. The fire guards must complete a signed inspection report. The fire guards or fire watch personnel must complete a signed inspection report (or the log book). **This report must be submitted to and retained by the person in charge of the torch operations.** The inspection report must be made available to any representative of the Fire Department and should be maintained on the premises for reasonable length of time (e.g. 48 hours) after work is complete.

PART 2. GAS TORCH EQUIPMENT

Gas torches are widely used for different purposes citywide. A fuel gas is used in the equipment to generate a flame to perform heating, cutting welding and brazing. Gas torches utilize two basic types of gas systems: blowtorch (air-fuel) and oxy-fuel.

Example of blowtorch (air-fuel)



Example of oxy-fuel torch



2.1 Blowtorch (Air-fuel) and Oxy-fuel Torch

2.1.1 Blowtorch (Air-fuel) torch or single tank torch

A propane torch is an example of a blowtorch, commonly used in torch-applied roof system. To provide enough oxygen for the torch to burn the fuel cleanly, the system mixes in air from the surrounding environment prior to ignition and while the torch is running. A container holds the fuel, while a tube carries it up to the nozzle. A valve near the nozzle lets in the air as needed.

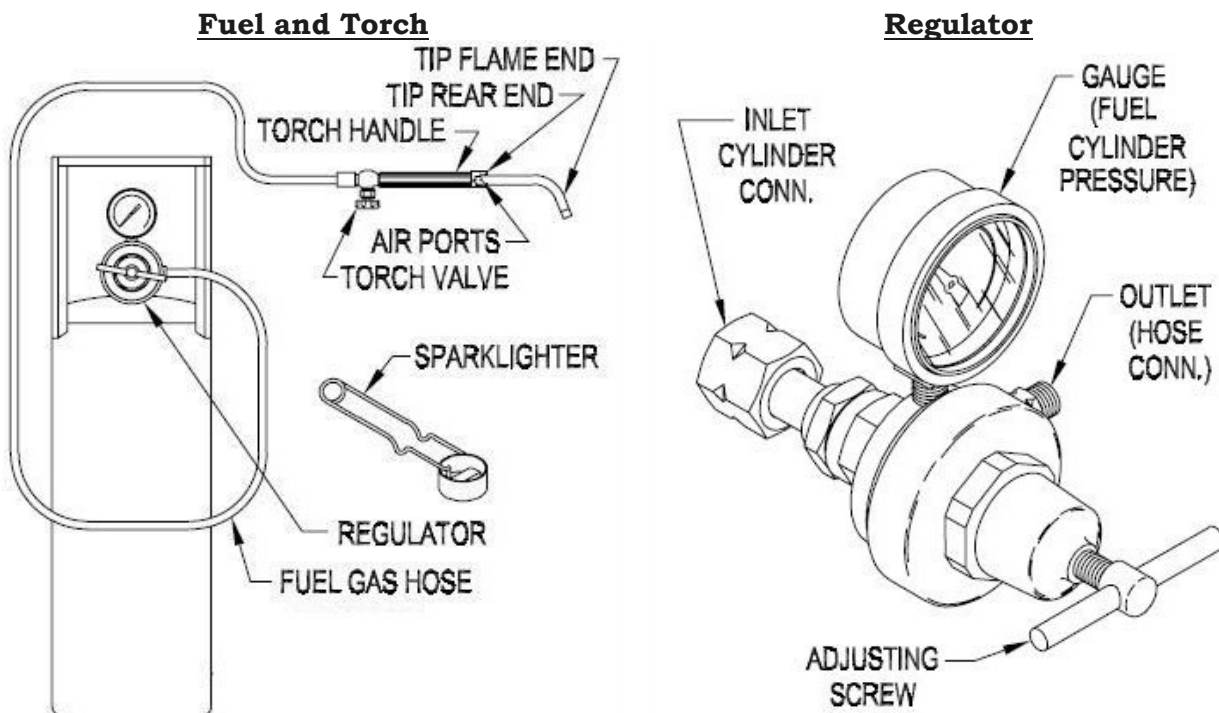

Revised on 11/5/2015

Most common fuel gases used in blowtorches are LPG (e.g. butane, propane), natural gas (methane) (either CNG or piped natural gas).

2.1.2 Oxy-fuel Torch

Oxy-fuel or oxygen-fuel gas torches have two separate containers: a pressurized fuel gas container and a pressurized oxygen container. The oxygen cylinder is made of steel and contains 100% oxygen. A mixture of oxygen and a fuel gas is used to generate a flame. The fuel gas is needed because oxygen does not burn by itself. Oxygen supports combustion and it maintains and controls the flame. In other words, the oxygen intensifies the burning of the fuel gas. For this reason, workers should never use oxygen to blow dirt off their clothes. Even a small spark could immediately ignite the clothing and cause serious injury. Using pure oxygen with the fuel makes the torch flame much hotter than the standard blowtorch torch. For example, Oxy-propane torches can produce about 1,500 degrees Fahrenheit higher than the air-propane torch can generate.

Some of the fuel gases used in oxy-fuel torches are LPG (e.g. butane, propane), natural gas (methane) (either CNG or piped natural gas), and acetylene. Acetylene is used because compared to the other fuel gases it creates the greatest amount of heat when burned (i.e. 3,000 degrees Fahrenheit higher than an air-propane torch).

Both gas containers have control valves on the top of the container. The valves control the discharge of gas from the containers. Gas containers also have a protective cap or protective collar. The protective collar is always located on the top of the LPG container. The caps should be screwed on over the valve when the cylinders are not in use. These caps/collars prevent the valves from being damaged. The oxygen is stored at pressures up to 2200 psi (pounds per square inch). It has a safety disk installed in the control valve connection of the oxygen container. This disk will burst if the oxygen pressure in the cylinder becomes too great. This allows the oxygen to escape into the air and prevents an explosion. The pressure is likely to change if the cylinder becomes hot (e.g. in a fire).

The fuel gas (e.g. propane, natural gas or acetylene) is stored at higher pressures to keep a sufficient amount of fuel available for torch operations. However, it is dangerous to use the fuel gas at pressures above 15 psi, especially for acetylene. For this reason, a regulator is installed on the fuel cylinder. The regulator makes sure that the fuel is discharged from the gas container at a safe pressure range.

The two gases, oxygen and the fuel gases, are mixed inside the torch. The torch operator controls the mixture of the gases by using valves on the torch. Adjusting the valves controls the shape and intensity of the flame. The oxy-fuel mixture is manually ignited by the operator when it leaves the torch.

An example of a typical oxyacetylene welding system is shown below.

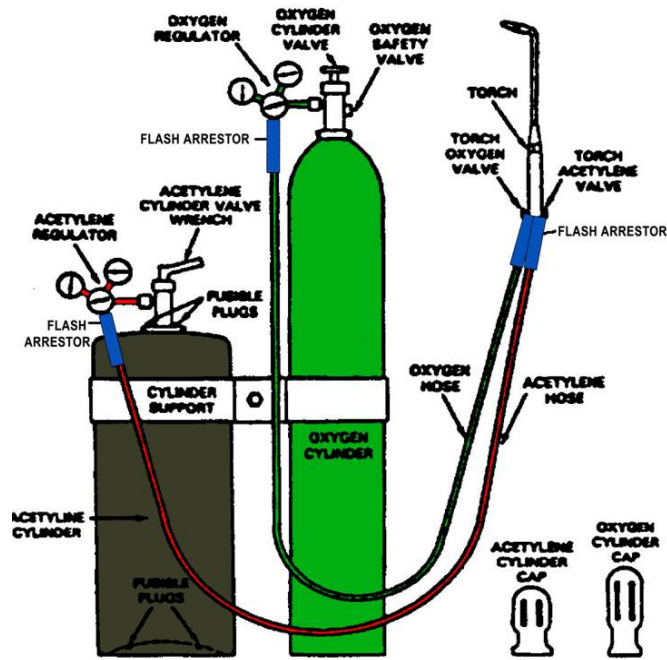

A Typical Oxyacetylene Welding System

2.2 Different Use of Gas Torches

2.2.1 Welding and cutting

Welding involves joining two or more pieces of metal together to form a single piece. Molten metal is generated through an intense heat source. Unlike welding processes which join two pieces of metal, cutting processes involve separating or severing a piece of metal through intense heat generated to melt the metal. Both welding and cutting processes often include oxygen and fuel gas. Oxy-acetylene generates the highest temperature which can reach up to 6,000 °F.



A Cutting Torch



A Welding Torch

2.2.2 Brazing and Soldering





Brazing and soldering are similar to welding in that both the base metal and the filler metals are heated to melting and then solidify to form a joint. However, soldering and brazing temperatures are typically 840 °F. Soldering or brazing typically involves smaller components to be joined and "softer" metals such as lead, tin or silver. Manual soldering processes use a hand-held iron to heat the components to be joined and the filler metals. A propane canister torch is often used for small tin-lead soldering jobs. It is a small disposable container of pressurized propane gas, and the container is attached with a reusable torch.

2.2.3 Heavy duty application

Gas torches also have applications for burning weeds, melting ice, or applying tar/asphalt to a roof. The flame is often a diffuse high temperature naked flame. The temperature can exceed 2000°F.

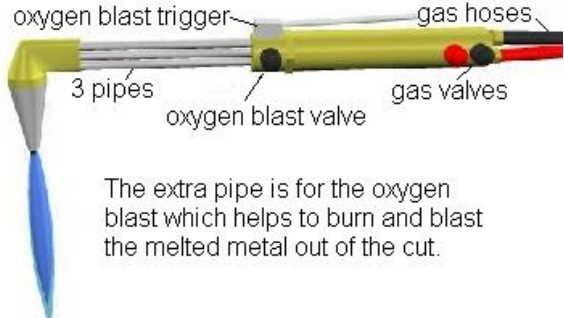
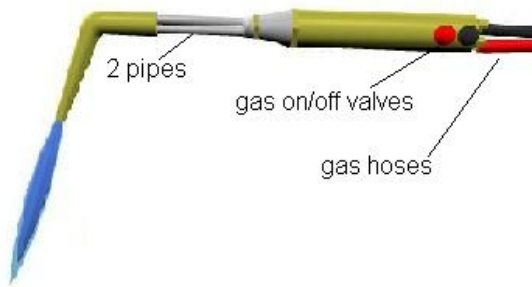

Table: Examples of different torch

Use	Temperature	Common Torch Types	Sample Picture
Cutting	> 2, 000 °F	Oxy-fuel torch	 <p>The extra pipe is for the oxygen blast which helps to burn and blast the melted metal out of the cut.</p>
Welding	> 2, 000 °F	Oxy-fuel torch	
Brazing and Soldering	Around 840°F	Blowtorch (most common) Oxy-fuel torch (large jobs or jewelry work)	
Heavy Duties	Wild range	Blowtorch	

2.3 Guidelines for Using an Oxygen-fuel Torch

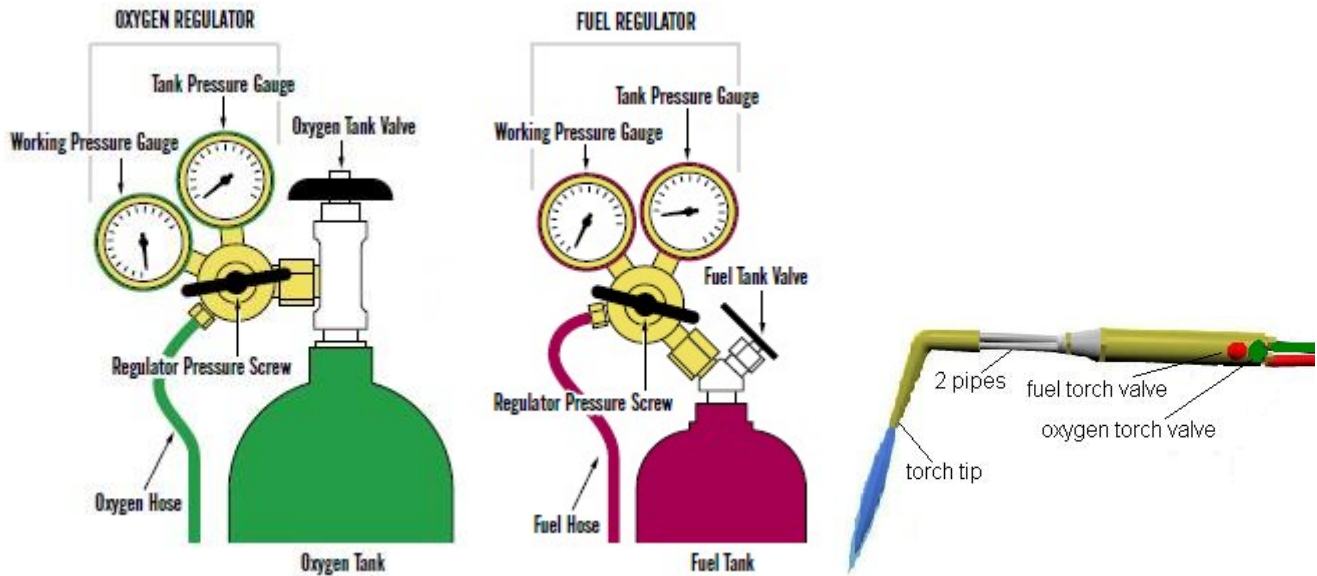

2.3.1 Set Up an Oxy-Fuel Torch

- Make sure that the valves and the regulators are clean.
- Do not over-tighten the regulator nut as this may damage the fitting.
- Oxygen and fuel gas container valves must be accessible to the torch operator or fire guard for immediate shutoff of the gas supply in the event of an emergency.
- Maintain a safe distance between the hot work area and the gas containers to protect the containers from heat, sparks, slag, or misdirection of the torch flame.
- Check for leaks. If any leaks are found, shut the supply valve, DISCONTINUE USE and contact the supplier/manufacturer and take the system out of service.
- If the fuel is piped natural gas, required protective flashback arrestor/checkvalve material must be installed as one of the following three options:

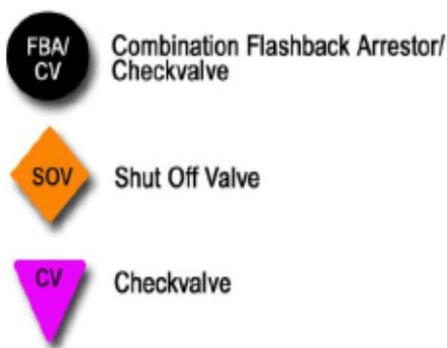
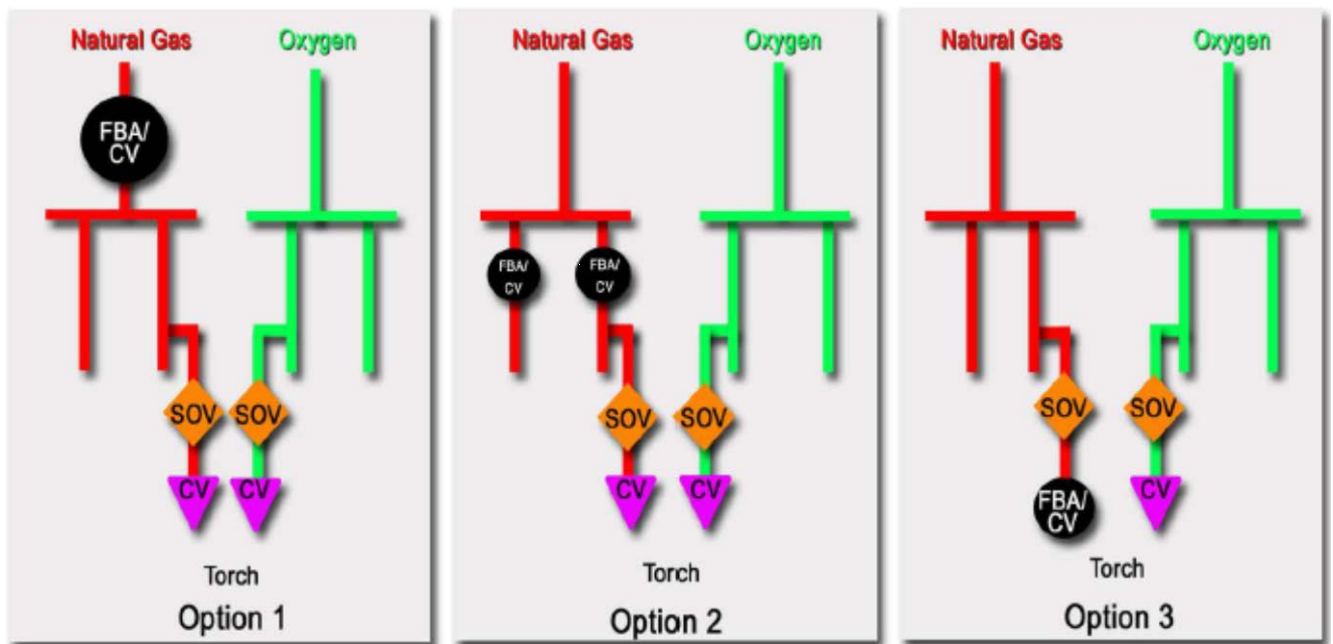

NFPA 51 offers three Options for placing the required protective flashback arrestor/check-valve in a manifold pipe system:

- Option 1: Put the flashback arrestor at the head end of the gas supply.
- Option 2: Place flashback arrestors in each branch of the manifold.
- Option 3: Places flashback arrestors at each torch.

Additional check valves are required at each torch in Option 1 & 2 and on the oxygen line in Option 3.

Shutoff valves are required on both natural gas and oxygen lines at each torch location.

2.3.2 Turn On an Oxy-Fuel Torch

- Open the gas container valve slowly and allow pressure to stabilize. The acetylene container valve should be opened by only 1/4 turn. The acetylene pressure should never be above 15 psi. If more acetylene is needed to supply, the larger torch hose should be used.
- Torch should be ignited by friction devices or other approved methods, should not use matches or other hot works.
- Once the flame is lit, open the fuel valve more and open the oxygen torch valve until the desired flame composition is achieved.

2.3.3 Turn Off an Oxy-Fuel Torch

- If the torch operation is to be discontinued for **a period of 1 hour or more**, the torch valve must be closed and the gas supply to the torch also must be completely shut.

- Turn off the gas torch valves. Some manufacturers suggest turning off the oxygen side first to prevent soot from building up inside the torch tip. But some may suggest first turn off the fuel gas torch valve. Then turn off the oxygen. **It is always best to follow the instructions for the torch you are using.**
- Close both the oxygen and fuel container valves completely.
- Open the torch valves, one at a time, to bleed the hoses. The pressure shown on both pressure gauges should drop to zero. Close the torch valves. Turn both regulator pressure screws counter-clockwise until they are loose.
- Disconnect the regulators from the gas containers or disconnect the hoses from the regulators.

2.3.4 Discontinued torch operations.

At construction site, when oxygen and acetylene torch operations are not in use, including when such operations are discontinued for the workday, the oxygen and acetylene containers shall be removed from the work area and moved to an approved storage area or removed from the premises.

Exception:

Brief interruptions in work of not more than 2 hours, including lunch breaks and coffee breaks.

2.3.5 Special Precautions for Using Oxy-fuel Equipment

(1) Avoid oil or grease

Containers, valves, regulators, hose and other apparatus and fittings for **oxygen must kept free of oil or grease**. Oxygen containers, regulators must not be handled with oily hands, oily gloves, or greasy tools or equipment. The oil and grease are more likely to ignite in the presence of oxygen. This is because the oxygen intensifies the burning of other materials. The mixture of pressurized oxygen and oil or grease may also cause an explosion.

(2) Never mix gases inside a container

Never attempt to mix oxygen and fuel inside a container. Never attempt to transfer oxygen or acetylene from one gas container to another.

2.4 **General Guidelines for Using a Blowtorch**

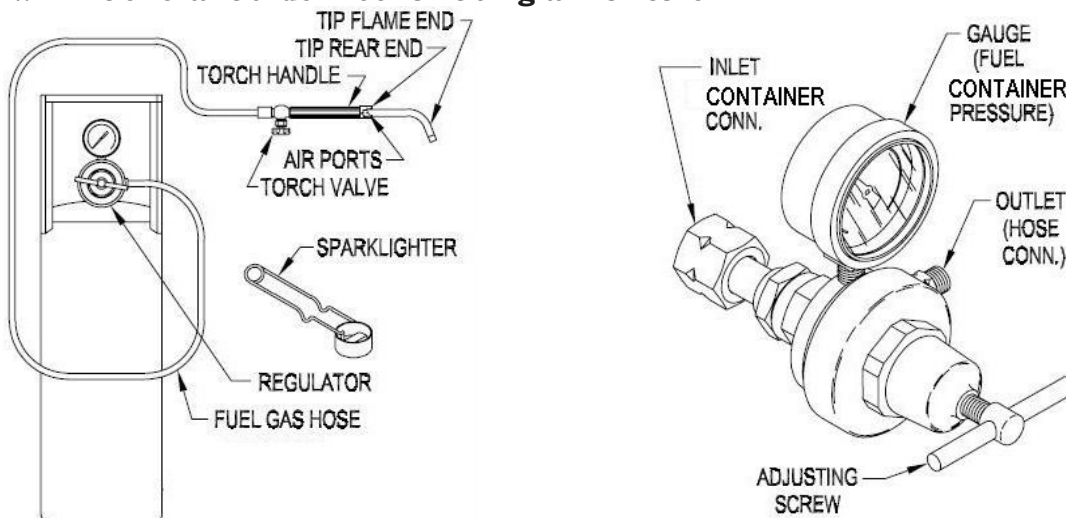

2.4.1 Set Up a Blowtorch

- Make sure that the valves and the regulators are clean.
- Do not over-tighten the regulator nut as this may damage the fitting.
- The fuel gas container valve must be accessible to the torch operator or fire guard for immediate shutoff of the gas supply in the event of an emergency.
- Maintain a safe distance between the hot work area and the gas containers to protect the containers from heat, sparks, slag, or misdirection of the torch flame.
- Check for leaks. If any leaks are found, shut the supply valve, DISCONTINUE USE and contact the supplier/manufacturer and take the system out of service.

2.4.2 Turn On a Blowtorch

- Open the gas container valve slowly and allow pressure to stabilize.
- Open the fuel torch valve a very small amount and light with a spark lighter.
- Torch should be ignited by friction devices or other approved methods, should not use matches or other hot works. Use the torch valve to control the size and heat of flame.

2.4.3 Turn Off a Blowtorch

- If the torch operation is to be discontinued for **a period of 1 hour or more**, the torch valve must be closed and the gas supply to the torch also must be completely shut.
- The torch system must be shut down as follows:
 - a. Close gas container valve.
 - b. Open torch valve and drain regulator and lines. DO NOT discharge toward people, flame or source of ignition.
 - c. Release regulator adjusting knob fully counterclockwise.
 - d. Shut off torch valve. Disconnect torch and regulator, replace the protective cap and plug to the hose end and supply tank respectively for overnight or longer shutdown.

2.5 **Common Problems Occur With Torch Operations**

2.5.1 Backfire

This occurs when the flame on the torch goes out unexpectedly. A loud snap or pop may occur when the flame goes out. Sometimes the flame will quickly relight. This happens when the working surface area is hot enough to re-ignite the flame. Backfire may be caused by several things that are easy to fix. The following is a list of some conditions that might cause backfire.

- (1) Touching the nozzle tip against the working surface.
- (2) Overheating the nozzle tip.
- (3) The oxygen and/or the fuel gas is set at the wrong pressure.
- (4) The cutting or welding tip is loose or dirty.
- (5) Dirt on the work surface.
- (6) Kinks or blockages in the hoses.

- (7) The nozzle tip is damaged and not seated properly in the torch head.

If backfire is noticed the container valves should be closed and the equipment checked for the symptoms listed above. If any dirt or damage is noticed, it should be cleaned or repaired before the equipment is used again.

2.5.2 Flashback

This occurs when the cutting or welding flame burns inside the torch or the hoses. It is usually accompanied by a whistling or hissing noise. As soon as the hissing or whistling is noticed the torch control valves should be closed. Then the fuel gas container valve should be closed. This allows the flame to burn itself out. After a few minutes the fire should have burned itself out.

Flashback indicates that there is something seriously wrong with the equipment. The equipment should be checked for damage or blockage. Check for the same conditions that might cause backfire. A build up of dirt may also cause the flashback. This can be a very dangerous situation. Care should be taken to make sure that it is fixed properly. If the equipment is not cleaned and repaired correctly it may result in an explosion. The entire system should be cleaned and repaired if needed. If the flashback happens again, a qualified technician should repair the equipment.

2.6 **Personal Protection**

The gas-torch equipment should only be used by trained and responsible personnel. Only the equipment approved by the Materials and Equipment Acceptance (MEA) should be used. The work area should be well ventilated. This will prevent the worker from breathing dangerous fumes. Exhaust fans may be used to draw the fumes away from the work area. An example of a well ventilated work area is shown below.

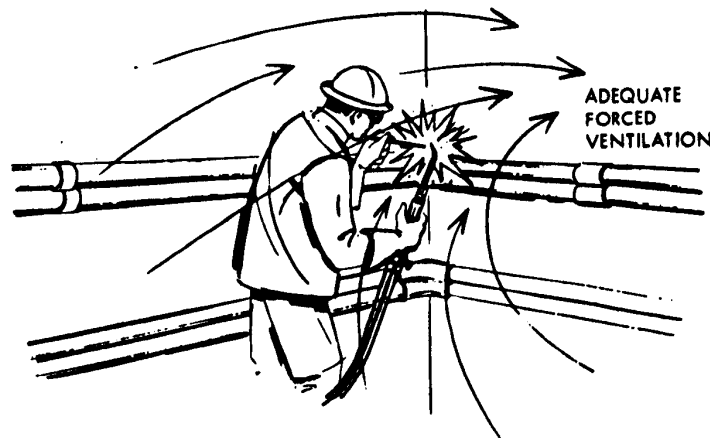

A Well Ventilated Work Area

The workers should wear flame resistant gloves and aprons, skull caps, helmets or goggles, and safety shoes. Clothing with pockets or cuffs should not be worn while working. Sparks or slag might catch in the cuffs or pockets. The following picture shows the appropriate safety clothing to wear while cutting and welding.



Frayed clothing is particularly susceptible to ignition and burning and should NOT be worn when welding or cutting.



Protective Clothing to be Worn While Cutting and Welding

PART 3. COMPRESSED GAS CONTAINER

The gases used by gas torches are commonly supplied in compressed gas containers, which can pose additional handling and transport hazards. All compressed gases are potential hazards because of the pressure within the container, their flammability, and/or their toxicity. The chemical is in gaseous form and pressurized, it can quickly contaminate a large area in the event of a leak.

3.1 Handling, Use, and Storage of Compressed Gas

3.1.1 General Guidance

(1) Label all compressed gas containers clearly

The contents of any compressed gas container must be clearly identified. Gas identification should be stenciled or stamped on the container or a label, and is typically applied near the neck of the container. **Do not rely solely on the color of the container to identify the contents. Do not use any container that is unmarked or has conflicting marking or labels.**

In addition, store, handle or use LPG in any equipment used or previously used for natural gas is prohibited in New York City, except as may be authorized by the commissioner on an emergency basis. On the other hand, store, handle or use CNG in any equipment used or previously used for LPG is also prohibited in New York City, except as may be authorized by the commissioner on an emergency basis.

(2) Do not refill container

The gas containers must be replaced when they are empty. It is illegal to refill gas containers in New York City. **Empty containers must be handled in the same manner as full ones.** They should be marked empty, the container valve or regulator tap must be closed and stored separately from full containers. All empty containers must be promptly removed by vendors. Damaged or otherwise unusable LPG/CNG containers must be promptly removed from the premises and lawfully disposed of.

(3) Upright position

All LPG/CNG containers must be secured in an upright position and must not be stacked or stored on shelves. The gas containers should be maintained in an upright position when being used. The gas containers used for on-sites jobs are usually secured on a handtruck. The containers are less likely to be damaged when secured to a handtruck. The handtruck permits the gas containers to be moved safely. All gas containers must be secured from tipping over, and should be stored in an upright position, and be equipped with a pressure regulator designed for the specific gas and marked for its maximum container pressure. You can use appropriate material, such as chain, plastic coated wire cable, commercial straps, etc., to secure gas containers.

(4) Well-ventilated areas

Indoor compressed gas storage and compressed gas use areas must be located in well-ventilation areas. LPG/CNG containers shall not be used in a cellar, basement, pit or other area below grade. LPG containers shall not be used in an above-grade under floor space or basement unless such location is provided with an approved means of ventilation.

Exceptions: Portable LPG containers are allowed to be used to supply approved self-contained torch assemblies. Such containers shall not exceed 16.4 ounces of LPG.

(5) Always replace the protective cap

Most gas containers have a protective cap, LPG containers have a collar. These devices protect the container control valve from physical damage. The protective cap is shaped like an inverted cup. It is screwed on top of the gas container. It must be in place when the gas container is not in use. The protective collar is welded onto the top of the container. The collar extends above the height of the containers control valve. An example of a container with a protective collar installed is shown below.

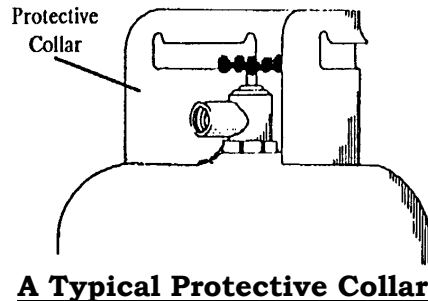

(6) Away from Temperature and Physical Damage

All gas containers and the related equipment must be protected from extreme temperature and physical damage. For example, gas containers for temporary stationary service must be placed on firm and non-combustible foundation. High temperatures (e.g. above 125 °F) can cause the pressure inside the container to increase to a dangerous level. A protective partition must be used to shield the containers that are exposed to hot air blown by a heating appliance. **All containers must be secured in an upright position, and must not be stacked or stored on shelves.**

(7) Regular Inspection

The Certificate of Fitness holder must regularly inspect the compressed gas containers, connections, and appliances for leaks. The damaged containers must be removed from services, repaired and tested by an authorized person.

Quick visual check of compressed gas containers:

- No extreme denting, gouging, or corrosion is on the compressed gas container.
- The container protective cap/collar and the foot ring are intact and are firmly attached.
- The container is painted or coated to minimize corrosion.
- The container pressure relief valve indicates no visible damage, corrosion of operating components, or obstructions.
- There is no leakage from the compressed gas container.
- The container is installed on a firm foundation and is not in contact with the soil.

3.1.2 Related Equipment

(1) Control valve and pressure relief valve

A control valve is on the top of each gas container. This valve can be opened or closed to control the discharge of the contents of the gas container. A handle is simply turned to open most gas control valve. **The control valve must be opened by hand.** A special key is needed to open the acetylene control valve. Adjusting the valves controls the shape and intensity of the flame. **Acetylene valves shall not be opened more than 1 1/2 turns.** Container valves shall be closed before moving a gas container, when the torch is not in use, and when the gas container is empty.

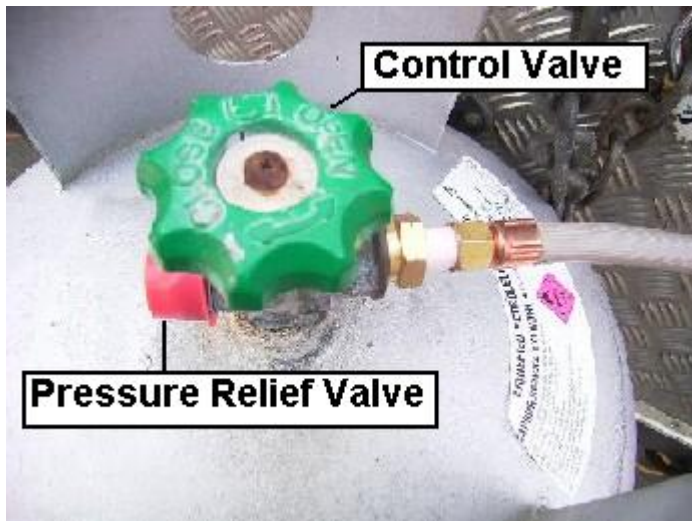

The **pressure relief valve** opens to allow the compressed gas to escape into the atmosphere when the pressure is too great in the container. This is a safety mechanism to prevent an explosion caused by the pressure build-up in the container. The relief valve or its discharge system must be designed to minimize the possibility of the entrance of water or dirt. If you observe or hear any gas leak from the pressure relief valve, call 911 immediately.

(2) Regulator

Before the gas containers can be used, a regulator must be attached to each of the control valves. A regulator is one of the most important parts of a compressed gas system. The purpose of the regulator is to control the flow of gas and lower the pressure from the container to the appliance. The regulator not only acts as a control regarding the flow and distribution of gas, but also as a safety barrier between the high pressure of the gas container and the end use appliance.

Always select the regulators recommended by the manufacturer. Do not interchange regulators between different sizes/types of container without consulting the manufacture. **Do not open the gas container valve or regulator tap until the regulator is securely attached.** Regulator connections to gas container valves must be completely free of dirt, dust, oil, and grease. The regulator controls the discharge rate of gas from the container.

Examples of typical regulators are shown as below.

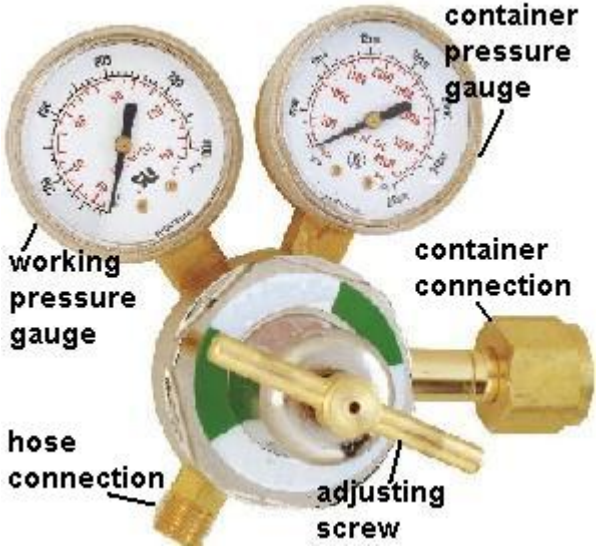
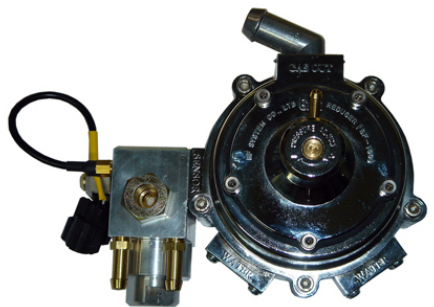
<p>A Typical Regulator of LPG Container</p>	<p>A Typical Regulator of Acetylene or Oxygen Container</p>
	
<p>A Typical Regulator of CNG Container</p>	
	

(3) Hose, Piping and Tubing

The regulator is also connected to a hose that supplies the gas to the appliance. This hose must be securely connected to the appliance. A rubber slip connection is prohibited. Only DOT approved hoses designed for a working pressure of 350 psi. are allowed. Generally speaking, nonmetallic pipe, tubing and components for any installation, appliance or equipment using LPG or CNG is prohibited. However, nonmetallic hose may be allowed at construction sites. **Hoses must be as short as practical protecting from mechanical injury**, but they must not be too close to an open flame. Hoses must be protected from physical damage and no hose is allowed to exceed 30 feet. When the gas containers are used inside buildings, the hose must not pass through any partitions, walls, ceilings, or floors. (NFPA 58 6.20.3.2)



This is designed for a rubber slip which is prohibited.

Piping in systems must be run as directly as is practical from one point to another, with as few fittings as practical. The use of nonmetallic pipe tubing, or hose for permanently

interconnecting gas containers is prohibited. All piping and tubing must be protected against damage by vehicles and by corrosion-causing substance.

3.1.3 Containers Connected for Use

A single container of oxygen and a single container of flammable gas may be installed on a cart provided that the containers are connected to regulators, equipped with apparatus designed for cutting, welding or other hot work operation, and are otherwise ready for use, and are stored, handled and used in compliance with the following requirements:

1. Carts shall be designed and used in accordance with Fire Code (refer to *Section 3.1.4 of this booklet, Moving Compressed Gas Containers*)
2. Container valves shall have a fixed hand wheel, or other approved means by which the flow of gas may be immediately shut down during hot work operations.
3. Container valves shall be closed at the end of each workday and whenever work is discontinued or the cart moved.
4. Container valve outlet connections shall conform to the requirements of CGA V-1.
5. Oxygen and fuel gas containers on the carts shall be located at a distance from the hot work area sufficient to protect such containers from heat, sparks, slag, or misdirection of the torch flame, or fire-resistant shields shall be provided.
6. A separation distance of 20 feet shall be maintained between such carts.

3.1.4 Moving Compressed Gas Containers

A compressed gas container must not be rolled on its side or its rim. It must be moved only by using approved lifting equipment. Where removable caps are provided for valve protection, such caps should be kept on containers at all times except when containers are in use. Do not lift containers by the cap. Valves of compressed gas containers must not be used for lifting.

CORRECT method of moving a gas container

Properly secured with chains

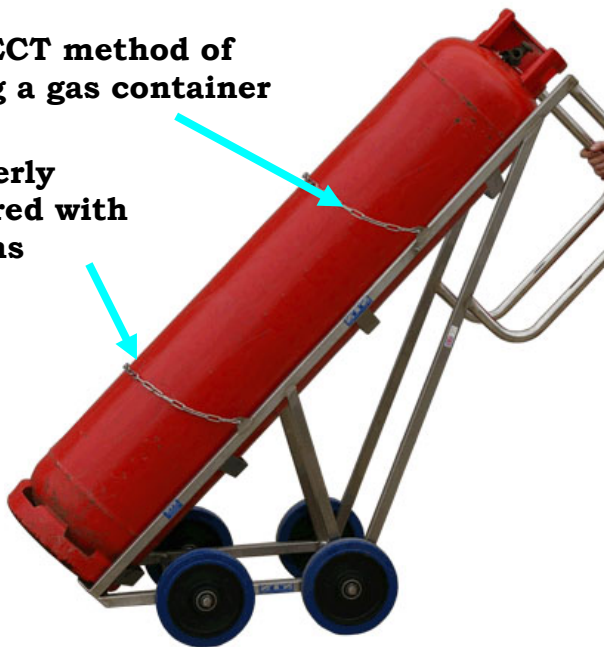

Containers shall be moved using an approved method. Compressed gas containers should be moved in an upright position, and must be moved using an approved method. Avoid dragging or sliding containers. Never drop containers nor permit them to strike against each other or against other surfaces violently. It is safer to move containers even short distances by using a suitable truck.

Where containers are moved by hand cart, hand truck or other mobile device, such carts, trucks or devices shall be designed for the secure movement of containers. Carts and trucks used to move materials shall not obstruct or be left unattended in any corridor, exit enclosure, or other means

of egress. Incompatible materials **shall not** be moved on the same cart or truck.

Carts and trucks utilized for moving compressed gas containers indoors shall be designed to provide a stable base for such movement during handling and shall have a means of restraining containers to prevent accidental dislodgement. Compressed gas containers placed on carts and trucks shall be individually restrained. Carts and trucks shall be provided with a device that will enable the operator to safely control movement by providing stops or speed-reduction devices.



Ropes, chains or slings shall not be used to suspend compressed gas containers unless such containers have been designed for such handling. Valves of compressed gas containers shall not be used for lifting.



1. Compressed gas container should be used, handled, and stored in upright position, except those designed for use in a horizontal position.
2. Compressed gas containers placed on carts and trucks must be individually restrained.

If the compressed gas containers need to be transported between different floors, if possible use an elevator (e.g. freight elevator, construction elevator, or passenger elevator when approved), and such elevator shall be occupied by the minimum number of persons.

All compressed gas containers may be transported only in approved vehicles. A FDNY transportation permit issued by the Bureau of Fire Prevention is required for each vehicle transporting quantities exceeding 400 SCF of any flammable gas (e.g. LPG/CNG), or exceeding 504 SCF of oxygen. Compressed gas containers may be delivered only to sites displaying a permit or Letter of Authorization issued by the Fire Commissioner.

3.1.5 Separation from hazardous conditions

The CNG and LPG and other flammable gases container storage must be located away from the following: Electric power lines; Piping containing flammable or combustible liquids; Piping containing flammable gases; and Piping containing oxidizing materials.

All compressed gas containers and systems in storage or use shall be away from materials and conditions that present potential hazards to them or to which they present potential hazards. It is recommended to group containers according to the type of gas (e.g. flammable, oxidizer) or whether containers are full or empty, if they are stored at the same location. **Fuel gas or oxygen containers in storage must be separated from any combustible materials by a minimum distance of 20 feet.** Oxidizing gases shall not be stored/used or come in contact with oil, grease, or other petroleum base.

Oxygen and acetylene storage areas on the floors on which the torch work is being conducted shall comply with the distance to exposure requirements

- 20 feet from all classes of flammable and combustible liquids, oxidizing gases and readily combustible materials, such as paper and combustible fibers.
- 25 feet from open flames, ordinary electrical equipment or other sources of ignition.
- 50 feet from air-conditioning equipment, air compressors and intakes of ventilation.
- 50 feet from other flammable gas storage.

Generally, the compressed gas containers shall be kept away from

- Sources of ignition
- Temperature extremes (Above 125 °F or less than mean low atmospheric temperatures)
- Corrosive chemicals or fumes
- Falling objects
- Public tampering
- Ledges, unprotected platforms, and elevators or other areas where the container could drop a distance exceeding one-half the height of the container

3.1.6 Storing Containers

A permit is required for any storage area storing (1) any flammable gas (e.g. LPG or CNG or acetylene) in excess of 400 SCF; or (2) any oxygen in excess of 504 SCF. The storage of compressed gases in quantities requiring a permit shall be under the general supervision of a proper certificate of fitness holder:

Gas Types	Certificate of Fitness for supervising the storage of the gases
LPG or CNG only	G-44
Acetylene or other flammable gases (not including LPG/CNG)	G-98
Oxygen or other nonflammable gases	G-46

3.2 Handling and Use of Acetylene Gas

Acetylene gas is a colorless, extremely flammable gas with a garlic-like odor. It is stored as a liquid in containers under pressure. **Copper tubing should never be used to splice the acetylene hose.** The copper tube will react chemically with the acetylene. The reaction may cause an explosion if the tube is subjected to a physical blow. Use of acetylene generators is prohibited in any hot work operations.

For use in welding and cutting, the working pressure must be controlled by a regulator. You should never set the regulator **above 15 psi as the acetylene will decompose explosively.** Acetylene leaks, no matter how small can have serious consequences.

The acetylene containers have safety plugs installed on the top and bottom of the container. These plugs melt if the container becomes too hot for it to be used safely. The melted plugs allow the gas to escape slowly. This prevents the container from exploding.

3.3 Handling and Use of LIQUID PETROLEUM GAS (LPG)

Liquefied petroleum gas (LP Gas or LPG) is often used as a fuel source. LPG includes propane, propylene, butane, and butylene. The most commonly used LPG is butane and propane. LPG is often referred to as "Bottled Gas". LPG is used in domestic, commercial, agricultural, and industrial settings. For example, propane is commonly used for domestic heating, cooking, and fuel for forklifts. Unless otherwise specified, the storage of LPG in quantities requiring a permit shall be under the general supervision of a person holding a Certificate of Fitness.

3.3.1 Description of Liquid Petroleum Gas

Manufacturing LPG is prohibited in NYC. **LPG is naturally colorless and odorless.** It is given an odor by mixing a foul-smelling additive with the gas (additive mercaptan). The additive causes LPG to smell like rotten eggs. This odor allows a leak of LPG to be easily detected. LPG is extremely flammable and highly explosive if ignited in an enclosed area. LPG is non-toxic, however, it can cause suffocation. **LPG is heavier than air** and tends to fall to the ground and spread horizontally. The use of LPG in a liquid form is prohibited in New York City, except withdrawing of LPG in liquid form from an LPG container for hot air balloon operations if required by the nature of the operation.

LPG is stored under pressure inside specially designed containers. The LPG is usually stored inside the container in a liquid state. Greater amounts of LPG can be stored when it is in a liquid form. For most uses the gas changes into a vapor when it leaves the container. When the gas changes into a vaporous state it expands to 269 times its original volume. **The expansion rate causes liquid LPG to be a much greater fire hazard than a vapor leak. A liquid LPG leak can cause an explosion even in an outdoor location.** Safety procedures must be strictly followed to reduce the danger a potential unintended release of LPG.

In New York City, LPG must be stored in portable containers which must be approved for use by the Federal Department of Transportation. **LPG Containers must be tested by the DOT approved vendors every five years.** The Certificate of Fitness holder is responsible for ensuring the container's condition including the marked date for statutory testing due. Container due for testing must be sent for testing to ensure that it is safe for use.

The containers are not filled to capacity with the LPG. A vapor space is left in the container to allow for expansion of the LPG. This is necessary because LPG expands when it becomes warmer. **Standard portable LPG containers are allowed to charge to a maximum of 100 pounds in weight. When portable containers are moved they must be secured to a specially designed hand truck. LPG containers and the related equipment must be protected from damage.** For example, LPG containers for temporary stationary service must be placed on firm foundation. Any containers with the bottoms of the skids or runners above the ground should be provided fire-resistive supports. Non-fire-resistive supports are only allowed when the Fire Department permits and the height of the outside bottom of the container does not exceed 5 feet above ground. (NFPA 58 6.6.5.4) LPG is

sensitive to temperature change. Very low temperature may inhibit the proper function of the gas. The reason is that LPG vaporizes at the temperature above 24°F-27°F (dependent on the gravity). If the temperature is below the vaporization point, it will not vaporize and it will remain a solid. Different LPG has different vapor temperature because of its different mixture components. For example, propane, the principal component of most LPG, has a temperature of vaporization of -44 °F at atmospheric pressure, but the temperature of vaporization of butane (also at atmospheric pressure) is much higher, +32 °F. As a result, once you need to use any LPG at a temperature below 32 °F, you should consult with the manufacturer for the boiling point of the LPG you use. High temperatures can cause the pressure inside the container to increase to a dangerous level. LPG Containers should never be allowed to reach a temperature exceeding 125 °F. A protective partition must be used to shield the containers that are exposed to hot air blown by a heating appliance. Any blower-type and radiant-type units must not be directed toward any LPG container within 20 feet.(NFPA 58 6.19.4.6) An example of a typical LPG container is shown below.



3.3.2 Safe Handling and Use of Liquid Petroleum Gas

LPG is highly explosive when it accumulates in one area. **As a precaution LPG must only be used in well-ventilated areas. The LPG container must not be placed or used underground or in a below grade location.** The container must remain above ground at all times.

A sign explaining safe handling procedures for LPG should be posted near all LPG appliances. This sign should indicate the following:

- a) How to handle LPG containers safely
- b) How to connect all regulators, manifolds, and hoses to containers and appliances
- c) How to detect LPG leaks safely
- d) How to start up and shut down the appliance and related equipment
- e) The names, address, and telephone number of a local supplier
- f) Emergency number: 911

Revised on 11/5/2015

The LPG containers must be secured in the upright position. The protective caps or plugs must be in place and container's valve must be closed when the containers are being transported or are not in use.

LPG containers with a capacity of 20 pounds shall be provided with transportation plugs that secure gas-tight the container's outlet valve connection. LPG containers with a capacity of more than 20 pounds shall be moved to another floor of the building only by freight elevator, construction elevator, or passenger elevator when approved, and such elevator shall be occupied only by those persons engaged in moving the containers. LPG containers with a capacity of 20 pounds or less shall be moved in the same manner, except that they may be moved in building stairwells if such stairwells are unoccupied.

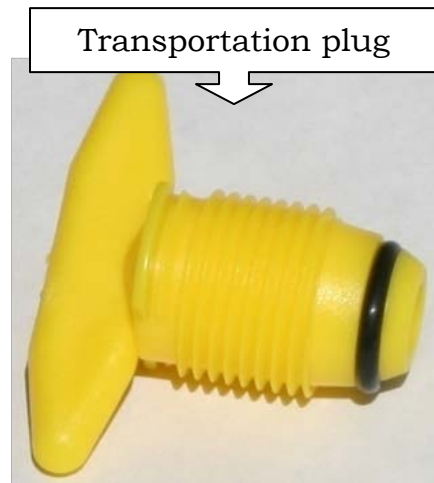

3.4 Handling and Use of Compressed Natural Gas (CNG)

CNG (Compressed Natural Gas) is made by compressing natural gas which is mainly composed of methane. Unlike the LPG, CNG does not liquefy under high pressure, it is stored inside the container in a gas state. **Any single CNG container must not exceed 381 SCF.** (Fire Code 3508.3)

Processed natural gas is tasteless and odorless. However, before gas is distributed to end-users, it is odorized by adding small amounts of odorants to assist in leak detection. Breathing natural gas in trace amounts is harmless; however, natural gas is a simple asphyxiant and can kill if it displaces air to the point where the oxygen content will not support life. It is prohibited to store, handle, use or sell any CNG that has not been satisfactorily odorized with mercaptans or other approved chemical.

Natural gas is a flammable gas. It can be hazardous to life and property by explosion. Natural gas is lighter than air, and tends to escape into the atmosphere. It makes CNG safer than LPG once there is a leak in the system. However, when natural gas is confined, such as within a building or other enclosed space, gas concentrations can reach explosive mixtures and, if ignited, result in blasts that could level and destroy buildings. Methane has a lower explosive limit of 5% in air, and an upper explosive limit of 15%. An example of typical CNG containers is shown below.



3.5 Check for Leaks

The gas containers, valves, hoses, and related equipment should be inspected for physical damage. Special care should be taken to identify any defects that may cause a leak. **Any defective components that are discovered must be marked and be replaced before the equipment may be used again.** If any leak of flammable gases or oxygen is detected, move the gas container to an isolated, well-ventilated area away from combustible materials. Post signs that describe the hazard. The **Certificate of Fitness holder must not attempt to do any repairs, but only take the equipment out of service.** This equipment is very sensitive and must be repaired by the manufacturer only.

After the new container has been connected to the appliance, all connections must be checked for leaks. Most of these leaks occur at the top of the gas container in areas such as the valve threads, pressure safety device, valve stem and valve outlet.

These areas must be checked using a soap and water solution. **NEVER CHECK FOR LEAKS WITH A FLAME.** First make sure that all connections are tight. Then open the container valve. Each connection is checked by brushing or spraying a soap and water mixture on the connection. The connection should be checked to see if any air bubbles are present. If no air bubbles are visible there is no leak. However, if bubbles are present there may be a problem with the connection. The suspected fittings should be disconnected and cleaned. Then the connection is tightened and the checking procedure is repeated. If the bubbles are still visible, there is a problem with the connection. The fittings should be repaired or replaced before the equipment is used again. **A lighted flame (for example, a match) should never be used when checking a connection for a leak.**

Soap and Water Solution

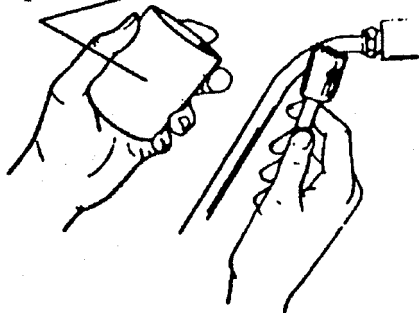

Occasionally, ice or moisture may build up on the regulator. Icy build-up indicates that the compressed gas is leaving the gas container in a liquid state. This is caused by a dangerous defect in the gas container. If ice build-up on appliance or connectors, shut off the main control valve of the fuel container, take it out of service, and return it to the supplier immediately. If the ice build-up is on the gas container itself or its control valve, you should call 911 immediately.

PART 4. PORTABLE FIRE EXTINGUISHERS

All persons conducting hot work operations or performing fire watch shall be trained in the use of portable fire extinguishers, and shall be capable of extinguishing fires when they are limited in size and spread such that they can readily be extinguished using a portable fire extinguisher.

A portable fire extinguisher with at least a 2-A:20-B:C rating (a minimum 3-A:40-B:C rating fire extinguisher on torch-applied roofing system operations) must be readily accessible within 30 feet of the location where hot work is performed and where the fire guards are positioned. In case of fire, 911 must be called.



In the event of a fire extinguisher has been discharged, a fully charged replacement is required before work can resume. **The C of F holder is recommended to be trained for the use of portable fire extinguisher.** Portable fire extinguishers are important in preventing a small fire from growing into a catastrophic fire, however, they are not intended to fight large or spreading fires. **The trained Certificate of Fitness holders should only consider extinguishing fires when they are limited in size and spread such that they can readily be extinguished using a portable fire extinguisher.** By the time the fire has spread, fire extinguishers, even if used properly, will not be adequate to extinguish the fire. Such fires should be extinguished by the building fire extinguishing systems or trained firefighters only. In case of any fire, FDNY must be notified. Fire extinguishers must be used in accordance with the instructions painted on the side of the extinguisher. They clearly describe how to use the extinguisher in case of an emergency. The Certificate of Fitness holder should be familiar with the use of portable fire extinguishers. When it comes to using a fire-extinguisher just remember the acronym P.A.S.S. to help make sure you use it

properly. P.A.S.S. stands for Pull, Aim, Squeeze, Sweep.

All fire extinguishers must be installed so that the top of the extinguisher is not more than 5 ft above the floor and the clearance between the bottom of the extinguisher and the floor is not less than 4 in. In other words, **no fire extinguisher is allowed to put on floor.**



Fire extinguisher in a construction site.



Improper floor placement of Fire Extinguisher.

4.1 Operation Instructions for a Fire Extinguisher

Special care must be taken when extinguishing a gas fire caused by a leak. The easiest way to extinguish the fire is to shut off by using the Emergency Shut Off valve until the flame is extinguished. **In case of any fire, Fire Department must be notified.** The flame must be approached from an upwind direction. This will prevent the Certificate of Fitness holder from being burned by the flames. **Never approach a fire from a downwind direction.** The correct ways to approach a fire are shown below.

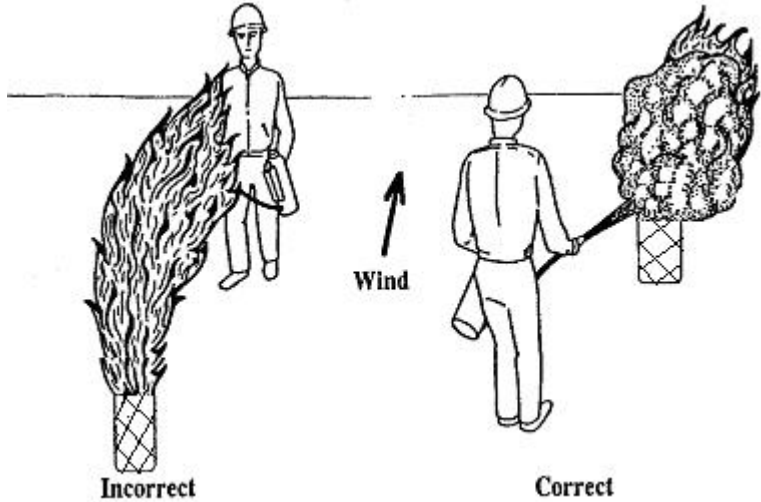

The dry chemical stream must be directed toward the point where the flame begins. **Do not direct the chemical stream at the center of the flame.** This will not extinguish the fire. The correct way to direct the dry chemical stream is shown below.

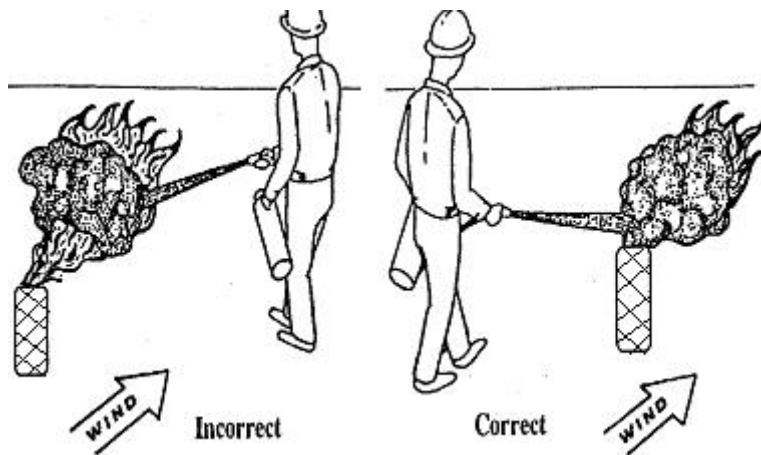

For the piped gas, the gas supply must be shut off first and then call 911. This is safer than allowing the flammable gas (e.g. acetylene or LPG) to leak out. A flammable gas leak could result in a serious explosion if it were ignited. **Never attempt to extinguish the flame unless the gas supply shut. When it is not possible to shut off the gas supply (e.g. the fire is near the control valve or the shut-off valve) and the gas supply is limited (e.g. it is from a cylinder), allow the flame to burn itself out and call 911.** In the meantime, you should try to control the scene and prevent the fire spreading to the surrounding materials. **The trained Certificate of Fitness holders should only consider extinguishing fires when they are limited in size and spread such that they can readily be extinguished using a portable fire extinguisher.** By the time the fire has

spread, fire extinguishers, even if used properly, will not be adequate to extinguish the fire. Such fires should be extinguished by the building fire extinguishing systems or trained firefighters only.

4.2 Fire Extinguishers

The Certificate of Fitness holder must be familiar with the different types of fire extinguishers available at the work site. The Certificate of Fitness holder must know how to operate the extinguishers in a safe and efficient manner. The Certificate of Fitness holder must also know the difference between the various types of extinguishers and when they may be used. A description of the classes of fires and the appropriate extinguishers are described below.

Class A fires are caused by ordinary combustible materials (such as wood, paper, and cloth). To extinguish a Class A fire, these extinguishers utilize either the heat-absorbing effects of water or the coating effects of certain dry chemicals.

Class B fires are caused by flammable or combustible liquids and gases such as oil, gasoline, etc. To extinguish a Class B fire, the blanketing-smothering effect of oxygen-excluding media such as CO₂, dry chemical or foam is most effective.

Class C fires involve electrical equipment. These fires must be fought with fire extinguishers that do not conduct electricity. Foam and water type extinguishers must not be used to extinguish electrical fires. After shutting off the electrical equipment, extinguishers for Class A or B fires may be used.

Class D fires are caused by ignitable metals, such as magnesium, titanium, and metallic sodium, or metals that are combustible under certain conditions, such as calcium, zinc, and aluminum. Generally, water should not be used to extinguish these fires.









A multi-purpose dry chemical fire extinguisher may be used to extinguish more than 2 Classes fires. Examples of some fire extinguishers are shown below.

Examples of fire extinguishers

10-B:C (10BC)	3-A:40-B:C(3A40BC)	3-A:40-B:C(3A40BC), wheeled
		

4.3 Typical Fire Extinguishers

Symbols may also be painted on the extinguisher. The symbols indicate what kind of fires the extinguisher may be used on. Examples of these symbols are shown below.

CLASSES OF FIRES	TYPES OF FIRES	PICTURE SYMBOL		
A	Wood, paper, cloth, trash & other ordinary materials.		 Class A, B & C Fires Multi-purpose Fire Extinguisher	
B	Gasoline, oil, paint and other flammable liquids.			 Class B & C Fires
C	May be used on fires involving live electrical equipment without danger to the operator.			
D	Combustible metals and combustible metal alloys.		 Class A & B Fires	
K	Cooking media (Vegetable or Animal Oils and Fats)		 Class A Fires	

Fire Extinguisher Identification Symbols

The symbol with the shaded background and the slash indicates when the extinguisher must not be used. The Certificate of Fitness holder must understand these symbols. All fire extinguishers should be kept in good working order at all times.

4.4 Fire Extinguisher Inspections

The extinguishers are required to be inspected monthly. The owner of the premises is responsible to designate a person to perform a monthly inspection. This inspection is a "quick check" that a fire extinguisher is available and will operate. It is intended to give reasonable assurance that the fire extinguisher is fully charged and operable. This is done by verifying that it is in its designated place, that it has not been actuated or tampered with, and that there is no obvious or physical damage or condition to prevent its operation. The information of the monthly inspection record must include the date the inspection was performed, the person performing the inspection, and those portable fire extinguishers found to require corrective action. Such recordkeeping must be either attached to the extinguisher or on an inspection checklist maintained on file. Labels or markings indicating fire extinguisher use, or classification, or both shall be placed on the front of the fire extinguisher. At least once per year, all fire extinguishers must be maintained by a FDNY approved company and a W-96 Certificate of Fitness holder.

